



FÉDÉRATION
INTERNATIONALE
DE NATATION



FINA ARTISTIC SWIMMING MANUAL FOR JUDGES, COACHES & REFEREES

2017 - 2021



TABLE OF CONTENTS

Table of Contents.....

Message from the FINA President

Foreword

FINA Bureau 2017-2021.....

FINA Technical Artistic Swimming Committee 2017-2021

SECTION I GENERAL INFORMATION FOR JUDGES.....

A. FINA Artistic Swimming Judges List

B. The Evaluation of Judges

C. FINA Artistic Swimming Evaluators Policies and Procedures

D. Selection of Judges

E. FINA Certification School for Judges

F. Ethics in Artistic Swimming

G. Forms

 1. FINA AS Judges List Activity Report

 2. FINA AS Judges List Confirmation Form

 3. FINA AS Judges List Nomination Form

 4. FINA AS Practice Judge Application

 5. FINA AS Evaluation Form

SECTION II FIGURES.....

A. Judging Figures.....

 1. FINA Rules for Judgement of Figures

 2. Guidelines for Figure Judging.....

 3. Deduction Guideline for Figures



4.	Basic Principles of Figure Judging	
5.	Expanded Marking Scale for Figures	
6.	Guiding Scale for Height Quality of Performance Technology	
	Guiding Scale for Height	
7.	Guiding Scale for Split	
B.	Identifying Difficulty in Figures	
1.	Identify Essential Synchro Specific Elements.....	
2.	Tables of Transition.....	
3.	2017-2021 FINA Figure Groups	
C	Analysis of Figures.....	
1.	Analysis of Basic Positions.....	
2.	Analysis of Basic Movements.....	
3.	Analysis of FINA Figures.....	

SECTION III ROUTINES

A.	Guidelines for Presentation of Routines	
B.	Free Routines	
1.	Free Routine Rules	
2.	Free Routine Scoring Rules.....	
3.	Judging Free Routines	
4.	Judging Execution.....	
5.	Judging Difficulty.....	
6.	Guiding Scale for Difficulty.....	
7.	Judging Artistic Impression.....	
8.	Expanded Marking Scale for Routines	
C.	Free Combination.....	
D.	Highlight Routine.....	



E. Technical Routines.....

 1. Scoring a Technical Routine.....

 2. Required Elements.....

F. Mixed Duet

G. Glossary of Terms

SECTION IV REFEREE GUIDELINES

A. The Referee.....

SECTION V MEDICAL ISSUES IN ARTISTIC SWIMMING

A. Illnesses in Artistic Swimming.....

B. Injuries in Artistic Swimming.....

SECTION VI GUIDELINES FOR APPROPRIATE CONDUCT AT COMPETITIONS

A. General Conduct.....

B. Conduct during Practices.....

C. Conduct during the Competition.....



MESSAGE FROM THE FINA PRESIDENT

It is my great pleasure to present to you the ***FINA Artistic Swimming Manual for Judges, Coaches and Referees***, a precious tool for all those in charge of developing and promoting this spectacular discipline in the five continents.

Artistic Swimming has dramatically progressed over the last years. In 2003, the launch of the Combination event in our World Championships brought another dimension to this sport; in 2005, the approval of the new programme for the FINA World Championships, “separating” the technical and free routines, led to new successes; in 2006, the creation of a FINA Synchronised Swimming World Trophy added an additional impact on the promotion of the sport; in 2007, the launch of the FINA Judges School was also an important milestone in the history of this discipline; in 2015, at the FINA World Championships in Kazan (RUS), mixed duets are introduced for the first time in the FINA programme; finally, in 2017, we had the first edition of a new competition, the World Series, and our Congress approved the change of the discipline’s name from “Synchronised Swimming” to “Artistic Swimming”.

The 2017 FINA Technical Congress, in Budapest (HUN), approved important changes that need to be correctly assimilated by the Artistic Swimming family. This Manual provides the keys for a homogenous and clear understanding on these new rules.

This discipline is in constant evolution. More events are organised on a local, national and international level, attracting an increasing number of young athletes on a global scale. The newly mixed events bring additional value and improved artistic performances to the Artistic Swimming world. The preparation of our coaches, the quality of judges and obviously the devotion of our competitors are strong assets of this winning strategy. Providing them this manual will enhance the assimilation and transmission of technical knowledge, basic tools in such a challenging and yet spectacular discipline.

I would like to express my gratitude to the FINA Technical Artistic Swimming Committee (TASC) for putting together this manual.

For the judges, coaches and referees, I am sure that this *FINA Artistic Swimming Manual* will be essential in the development of your activities. Together with the athletes and the support you receive from your respective National Federations, you are the pillars of the future development of this discipline in the five continents!

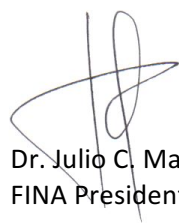

Dr. Julio C. Maglione
FINA President



FOREWORD

The original edition of this manual was published in 1993 under the guidance of editor, Judith McGowan, Chairman of the Technical Synchronised Swimming Committee from 1984 -1992. Since 1993 it has been updated every four years following each FINA Technical Congress.

This Manual is recognised worldwide as a useful reference for judges, coaches, referees and athletes. Through it, all Artistic Swimming participants have access to the same information, guidelines and interpretation of the FINA rules. In 2007, the manual became the main document used in the FINA Judges Training Schools.

Major contributors to this and/or previous editions are Bill and Mary Black, Dawn and Ross Bean, Judy McGowan, Steffi Haeberli, Ulla Lucenius, Saeko Zushi, Sandra Roberts (former editor), Dr. Margo Mountjoy, Virginia Jasontek, Carol Tackett, Sue Edwards, Miwako Homma, Petra Loeck, Barbara McNamee, Diane van der Pol, Hortensia Graupera, Maria José Bilbao, Inger Lindholm, Christiane Brenner, Ana Maria Lobo, Marina Roshina, Marie Claude Besançon, Betty Hazle, Heather Archer, Jennifer Gray, Danae Christou and Lisa Schott. We thank these contributors along with other FINA Judges and Coaches who have been involved in the on-going process of providing up to date information and analysis.

Production of Artistic Swimming educational materials such as this Manual would not be possible without the financial support of FINA, the excellent work of the FINA Office Staff and the leadership of the TASC. Special recognition and thanks to all former and current TASC members who provided input to this and to previous editions.

On behalf of the Artistic Swimming family around the world who will use this Manual, thank you all very much! Your contributions are greatly appreciated.

Lisa Schott – FINA TASC Chairman 2017-2021

Virginia Jasontek – FINA TASC Vice Chairman 2017-2021

Olga Brusnikina – FINA TASC Honorary Secretary 2017-2021

Tamas Gyarfas – FINA Bureau Liaison for Artistic Swimming 2017-2021



FINA Bureau 2017 – 2021

PRESIDENT	Dr. Julio C. Maglione (URU)
FIRST VICE PRESIDENT	Husain Al Musallam (KUW)
SECOND VICE PRESIDENT	Sam Ramsamy (RSA)
HONORARY TREASURER	Pipat Paniangvait (THA)
VICE PRESIDENTS	Paolo Barelli (ITA) Dale Neuburger (USA) Dennis Miller (AUS)
MEMBERS	Khaleel Al Jabir (QAT) Taha Sulaiman Dawood Al-Kishry (OMA) Algernon Cargill (BAH) Errol Clarke (BAR) Dimitris Diathessopoulos (GRE) Dr. Mohamed Diop (SEN) Matthew Dunn (AUS) Zouheir El Moufti (MAR) Mario Fernandes (ANG) Tamas Gyarfas (HUN) Penny Heyns (RSA) Andrey Kryukov (KAZ) Dr. Margo Mountjoy (CAN) Juan Carlos Orihuela (PAR) Donald Rukare (UGA) Vladimir Salnikov (RUS) David Sparkes (GBR) Daichi Suzuki (JPN) Erik Van Heijningen (NED) Jihong Zhou (CHN)
HONORARY LIFE PRESIDENT	Mustapha Larfaoui (ALG)
EXECUTIVE DIRECTOR	Cornel Marculescu



FINA Technical Artistic Swimming Committee 2017 – 2021

Chairman	Lisa Schott (CAN)
Vice Chairman	Virginia Jasontek (USA)
Honorary Secretary	Olga Brusnikina (RUS)
Members	Danae Christou (EGY) Esther Croes (ARU) Livia Gut la Ragione (ITA) Miwako Homma (JPN) Yan Liu (CHN) Feilina Feisol (MAS) Jennifer Naidoo (RSA) Anna Nepotacheva (AUS) Jong Ran Pak (PRK) Svetlana Saidova (UKR) Laura de Renziz (ITA)
Events Sub-Committee:	Maria José Bilbao (ESP) Elmira Fayzullaeva (UZB) Maria Thivaïou (GRE)
Athletes Representative:	Virginie Dedieu (FRA)
Bureau Liaison	Tamas Gyarfas (HUN)



SECTION I

GENERAL INFORMATION FOR JUDGES



A. FINA ARTISTIC SWIMMING JUDGES LIST

1. All FINA Member Federations may submit an unlimited number of names of judges to be considered for inclusion on the FINA “G” List. Only judges nominated by their federation to be on the FINA list can attend a FINA Certification School for Judges, and take the Test. All nominations must be submitted to the FINA Office in Lausanne, Switzerland by November 1st in any given year.
2. Each Federation must complete an activity report for each of its FINA List judges when requested to do so by the FINA Office. Regular activity reports ensure that each judge’s record is current and complete.
3. FINA List Policies:
 - a. Each Judge shall be classified as “A” or “G”
 - b. There is no limit to the number of “G” List judges per Federation.
 - c. Each Federation may have a maximum of 10 Judges on the “A” List.
 - d. The FINA Technical Artistic Swimming Committee is the only body which may classify a judge to the “A” list, subject to the approval of the FINA Bureau.
 - e. Members of the TASC are in addition to the maximum quota of “A” Judges allowed per Federation, and are identified on the FINA List as “F”. When such individuals are no longer members of the TASC, two things shall be considered when determining his/her subsequent status as a FINA official:
 - FINA List rating when he/she became a member of the TASC
 - Judging activity during his/her term on the TASC

If his/her Federation’s quota is at the maximum level, the former TASC member shall be in addition to the quota until a vacancy becomes available. If a former member was not on the FINA Judges list when initially named to the TASC, status shall be determined on the basis of judging activity during his/her term on the TASC.

4. The maximum age for a Judge to be included in the FINA Artistic Swimming Judges List is sixty-five (65), as per the FINA Rule BL 6.
5. The FINA Artistic Swimming Judges List will be published annually by FINA.



B. THE EVALUATION OF JUDGES

1. FINA List judges are expected to attend and to be evaluated at a minimum of four (4) competitions over a period of four (4) consecutive years. Federations with judges on the FINA List should enable them to officiate at competitions where they can be evaluated by a FINA recognised evaluator.

The evaluation process will include:

- Observation by one or more FINA evaluators
- Statistical evaluation on a FINA approved computer program
- Evaluations must be from competitions where the current FINA Judging Systems are used.
- Evaluations must be from competitions which have had at least 3 federations participating.
- Evaluations must be from judging at least 3 sessions in the competition.

2. JUDGES' EVALUATION SCALES

Overall

5. Very Good
4. Good
3. Satisfactory
2. Deficient
1. Weak

Lack of Bias

3. Good
2. Acceptable
1. Unacceptable

3. FINA JUDGES CLASSIFICATION CRITERIA

From "G" to "A":

- A Judge must have attended a FINA Certification School for Judges and passed the Test once every four years.
- A minimum of six (6) evaluations in a six year period, with the two most recent evaluations in the previous two years.
- One evaluation may be as a practice judge.
- Four (4) Evaluations must be Very Good (5) or Good (4) Overall.
- Two Evaluations may be Very Good (5), Good (4) or Satisfactory (3) Overall.



- Evaluations for Bias (i.e. Lack of Bias) must be Good (3) or Acceptable (2).
- If a Judge receives an evaluation of Unacceptable (1) for Lack of Bias from any competition then the evaluation from that competition shall be deemed invalid.
- At least two evaluations must be from competitions outside the Judge's own Continent, or from a competition where at least six Federations from two or more Continents participate.
- At least three evaluations must be from an Evaluator from a different country to that of the Judge, with the exception of FINA TASC members who are FINA Evaluators.
- At least two evaluations must be from a Senior competition, and at least two evaluations must be from a large Junior or Age Group competition.
- At least two evaluations must be from a competition with competitors from a different Continent to that of the Judge.
- At least two evaluations must be from competitions with entries from ten (10) or more Federations.
- Competitions which may be taken in to consideration for re-classification :
 - Continental Championships – Senior, Junior or Age Group
 - Competitions which have a FINA Evaluator appointed, either by FINA or by the Host Federation.
 - Major Regional or National Federation Championships which have a FINA Evaluator.

4. FINA JUDGES RE-CLASSIFICATION PROCEDURES

To remain on the "A" list judges must:

- A Judge must have attended a FINA Certification School for judges and passed the Test once every four years unless otherwise directed by the FINA TASC.
- Demonstrate Annual Activity, which is reported on the Activity Form required by the FINA Office.
- Annual activity may include officiating at National Championships, judging at competitions of other Federations, presenting or attending Judges' Training Clinics, either domestically or in another country, judging at International Competitions, or acting as a FINA approved Evaluator.
- Have at least four evaluations of Very Good (5), Good (4) or Satisfactory (3) in a four year period, from four different competitions, of which two must be in the immediately preceding two years.
- At least two of the evaluations must be from an Evaluator from a country other than that of the Judge, with the exception of TASC Members who are FINA approved Evaluators.



- One of the evaluations must be from a Senior competition and one of the evaluations must be from a large Junior or Age Group competition.

Judges may be re-classified on the FINA Judges List from “A” to “G” for lack of evaluated International activity during four consecutive years in the current quad.

5. PRACTICE JUDGING

- Of the six evaluations required for re-classification from “G” to “A”, one may be as a Practice Judge.
- For World Junior Championships, World Championships, the FINA World Series and the Olympic Qualification Tournament, Federations may submit applications for Practice Judges to the Honorary Secretary of the FINA TASC. Applications must be submitted no later than 60 days prior to the competition.
- Federations are permitted to have one Practice Judge per competition, and the Host Federation is permitted to have two Practice Judges.
- Practice judging is not permitted at the Olympic Games.
- To be eligible to be a Practice Judge at any of the aforementioned competitions, a Judge must have attended a FINA Certification School for Judges and passed the Test.
- FINA “A” list judges are not permitted to Practice Judge at the aforementioned competitions.

6. EVALUATION REPORTS

The evaluation data is reviewed and compiled into individual judge’s reports by the FINA evaluator.

- Each report is included in the Judge’s file, to become part of the basis for decisions regarding remaining on the List, and/or re-classification.
- The report serves as a constructive feedback for the judge, with the objective of improving International judging standards.
- The evaluation files will be used to assist the TASC in selecting judges for the World Championships, the Olympic Games and the Olympic Qualification Tournament.



Each FINA sanctioned evaluator shall, to the best of their judgment, determine how accurately a judge scores routines and figures according to the criteria set forth in the FINA Handbook. Additional factors to be considered include:

- use of the score range
 - independence of opinion
 - level of concentration
 - evidence of bias
 - promptness in arriving at and presenting scores
 - ability to make decisions
 - punctuality and general impression
 - professional attitude and appropriate dress codes
- (i) Federations' organising committees where a FINA sanctioned evaluator is present are expected to co-operate fully with the evaluator. The host federation is expected to use a FINA approved computer software program to produce the judge's analysis, to accompany the Competition Results.
- (ii) FINA sanctioned evaluators are expected to provide their report to the FINA Judges Data Base Manager within 60 days of the competition.
- (iii) It is recommended that the evaluator meet with the judges either during or after the competition for the purpose of constructive feedback.
- (iv) Evaluation Reports are sent to the FINA Judges' Data Base Manager, and the individual judges. Evaluation Reports are not sent to the Federation. If possible, the Reports should be sent to the Continental Judge Data Base Managers.



C. FINA ARTISTIC SWIMMING EVALUATORS POLICIES AND PROCEDURES

1. The FINA Artistic swimming Evaluators List shall be composed of twenty current “A” list judges appointed by the TASC for a four year period. Federations may nominate up to two qualified judges for consideration. The nominated judges must have served as FINA “A” judges for a minimum of five years.

Note: Evaluators must attend a FINA seminar for Evaluators as requested. Evaluators must attend a FINA Judges’ Certification School and pass the test once every four years unless otherwise directed by the FINA TASC.

2. Federations hosting a competition may invite, at the Federation’s expense, a FINA sanctioned evaluator. Federations are requested to notify the FINA Office of the name and date of the competition and the name of the invited evaluator.
 - Evaluators are expected to attend all Technical meetings and Judges Meetings during the competition.
 - Evaluators should be seated on the deck or on the judge’s platform during competition.
 - Evaluators unofficially judge every session to compare their scores with those of the judges being evaluated.
 - Judge meetings for the purpose of feedback are held at the conclusion of each session if appropriate, or following finals.
 - Evaluators should ensure they receive the postal addresses of all judges, and their e-mail addresses where possible.
 - Copies of the completed evaluations shall be sent to the Data Base Manager within 60 days of the competition. In cases where the time limit is not strictly observed, the evaluator may be omitted from the list.
 - Evaluators should retain the originals of the completed evaluation forms.



D. SELECTION OF JUDGES

- Selection of judges for the Olympic Games, the Olympic Qualification Tournament, the World Championships, and other FINA competitions will include consideration of the following:
 - a. FINA List rating
 - b. Recent activity
 - c. Regional distribution
- For World Championships, the Olympic Qualification Tournament, and the Olympic Games only FINA List "A" judges who have judged at least 2 evaluated International competitions in the previous two years shall be selected. Refer to FINA BL 9.1.
- For the World Junior Championships each Federation may send two judges. This may be an "A" and / or a "G" judge who has judged at a minimum of 2 International competitions in the previous 2 years.
- Conflict of Interest:

Judges with a conflict of interest will not be selected for events/competitions where they have a conflict of interest. The following categories of people are deemed to have a conflict of interest:

- a) a relative of a Competitor
- b) a current Coach of a Competitor (conflict of a coach is not to stop coaches from judging but only to identify a conflict if there is one (example coach duet at 13 - 15 age group)
- c) a parent, child, sibling or spouse of a Coach of a Competitor
- d) a Team Manager or relative of a Team Manager
- e) an inhabitant of the same household of any of a), b) c), or d)

A "relative" includes step relationships and is any of parent, child, sibling, uncle, aunt, nephew, niece, first cousin, grandparent, or spouse, and a "coach" is any person who coaches figures and/or routines on a regular basis.

- Qualified members of the TASC may be used as judges at any FINA competition.
- The number of judges appointed to the Olympic Games is determined by the IOC and/or the FINA Bureau.



- Judges for other certified competitions may include representatives from all Federations participating in the competition. Judges from Federations not participating may be permitted to judge at the discretion of the Organizing Committee.
- To be considered for judging at a FINA competition, a judge must have successfully passed the Judges Exam administered at a FINA Certification School for Judges unless otherwise directed by the FINA TASC.



E. FINA CERTIFICATION/ DEVELOPMENT SCHOOL FOR JUDGES

1. Goals of the program:

- To provide and set the necessary competences to become a FINA judge, to promote sports growth and to offer a continuous learning for active judges.
- To provide universal teaching/learning materials for the different needs in schools and clinics, following the general principles fixed on the FINA Development brochures for schools.
- The objective of the FINA Artistic Swimming Schools for Judges is to establish a universal, standardized Judges Training and Certification Program.

The Certification Schools and Testing system will prepare and certify highly qualified FINA list judges in “A” or “G” category.

- *It is important to note that to be considered for judging at a FINA competition, a Judge must have successfully passed the Judges Exam administered at one of the FINA Certification Schools for Judges every four years unless otherwise directed by the FINA TASC.*

The FINA Certification Schools are for those Judges on the current FINA list. FINA Evaluators must attend a FINA Certification School for Judges and pass the test once every four years unless otherwise directed by the FINA TASC.

- Instructions will be given by a team of lecturers/ instructors appointed by the TASC.
- The curriculum will be based on the 2017-2021 FINA Artistic Swimming Manual for Judges, Coaches and Referees.
- Instructors will recommend to the FINA TASC, a list of judges who have participated and successfully passed the FINA judge exam at a FINA Certification School.
- For the exam writing, interpreters and use of online resources and cell phones are not permitted. Paper dictionaries are permitted.
- To receive certification, a Judge must attend a FINA Artistic Swimming Judges Certification School and pass the test with a minimum score of 85% for A Judges, and 80% for G Judges.

The official working language for the FINA Artistic Swimming Certification Schools for Judges is English.

At least ten (10) FINA judges must attend in order to have a FINA school.

If a participant is absent one day from the school, he/she can't take the test.



If a participant is absent a half day for unusual circumstances, he/she must provide the reason for his/her absence to the instructor. This will be taken into consideration by the instructor in determining whether the participant will be allowed to take the test.

2. The FINA Certification School for Judges

These schools are conducted by lecturer(s) of the FINA TASC (or instructors appointed by the FINA TASC).

The school runs for three days concluding with the Exam.

Certification instructors are appointed by the TASC and Commission based on the following:

- Continental representation
- Proven experience with teaching and facilitating courses/seminars
- Proven professionalism and neutrality
- Evaluation excellence
- Superior communication skills

Priority for attendance at certification and development schools shall be:

- The maximum number of participants is 30.
- Judges who have registered through the GMS for certification by no later than the registration deadline established per each School).
- One coach per Federation is allowed to attend as an Observer, provided that he/she is registered through the FINA GMS by the established deadline and that the maximum number of participants has not been reached.
- If there are additional spaces available, FINA age eligible judges (65 and under) and active national level coaches may fill the remaining spots. They must be registered through the FINA GMS as an Observer and will be approved by FINA on a first come first serve basis.
- The registration for the school will be closed once the maximum number of participants has been reached.
- Observers are not entitled to take the test.
- Each approved designated Federation coach will be required to submit a written report to the FINA Coaches Committee within 30 days of the school.
- The FINA Coaches Committee will then provide a consolidated report to the TASC at the end of the certification year.



3. Ongoing Certification for FINA Judges

Each FINA certified judge (unless otherwise directed by the FINA TASC) must take an annual online officials' exam. FINA will be developing this and 2018 will be the first year it is implemented.

A minimum score of 85% for A Judges, and 80% for G Judges will be required to earn a passing grade.

4. The FINA Development Schools

- Instruction will be theoretical/practical with video support.
- The curriculum will be delivered in progressive modules and adapted to the required level.

In order to begin the training as an Artistic Swimming Judge, FINA offers to all National Federations "FINA Artistic Swimming Development Schools for Judges" at three levels: beginner, intermediate and advanced. Any Federation may request to host a FINA Artistic Swimming Development School for judges as follows:

Beginners Development Schools are designed to meet the needs of the National Federations (NF) who have requested judge training. The school is designed for judges with limited basic knowledge or no experience in the judges training program.

Intermediate Development Schools are designed for National Federations (NF) that have judge training programs in place and host national age group competitions. Judges participating will be knowledgeable, active and experienced requiring more in depth training of skills at an intermediate level.

Advanced Development Schools are designed for National Federations (NF) that have their own judge school programs and want to promote their national judges to be qualified as FINA Judges. More in depth training of skills at an advanced level. This school is designed to help prepare participants to attend, participate and certify at a FINA Artistic Swimming Certification School for Judges. Recommended for NF running national Artistic Swimming AG and Senior competitions.

At the conclusion of the school, all participants will take a test.

In order to pass the Development school, participants must:

- -obtain a minimum score of 80% at the Beginner level.
- -obtain a minimum score of 80% at the Intermediate level.
- -obtain a minimum score of 85% at the Advanced level.

Participants obtaining a minimum score of 85% or more at the Advanced level of a FINA Development School are permitted to participate at a FINA Artistic Swimming Certification School if his/her NF submits the application for the FINA AS Judges List following the current FINA procedures and meeting the requested timelines.



The following individuals DO NOT need to attend a FINA Artistic Swimming Development School and may challenge the system and attend a Certification School to write their exam:

National Team Elite Swimmer (retired), National Team coaches / and national Judges, as long as the following requirements have been met:

- Significant judging activity at a national level involving different age groups for a minimum of 3 years.
- Judging at international events hosted by their own Federation.
- Proven judging ability with strong evaluations from an evaluator for a minimum of 3 years.

Federations wishing to nominate a candidate for consideration must forward the name to the TASC Chair and submit the required paperwork according to the timelines.

Instructors from the Certification Schools will deliver the FINA Artistic Swimming Development Schools for Judges.

The FINA TASC Commission has the authority to appoint additional instructors as required. In this case, the FINA Development School Instructors will be selected from the pool of current and certified active FINA A Judges from the current FINA list.

Host Federations must have a minimum of 10 people attend a Development School. FINA Artistic Swimming Development Schools for Judges are open to all NFs interested in developing judges that are not on the current FINA list. Judges will receive a diploma. Development Schools are organised over 3 to 5 days as requested by the NF.

NEW Certification Schools can be hosted separately or combined with a Development program as long as each school meets the requirements described above. Maximum registered delegates for all FINA Artistic Swimming Schools is 30 people per school including coaches. The registration for the schools will be closed once the maximum number of participants has been reached.

Two FINA Certified Instructors will deliver two different streams: the development program and the certification program. There will be parts of the curriculum that are shared and parts that the instructors break out into their own groups. This format allows for mentoring opportunities between officials.

NEW. Coaches may attend Development/Certification Schools as an observer without the right to take the exam. The coaches must submit a written report of key learnings and recommendations for the future to the Coaches Commission.
Please note: the nationality of the Officials will be verified by FINA office in GMS.



F. ETHICS IN ARTISTIC SWIMMING

Ethics: *“the philosophy of morals“*

“the rules or standards governing the conduct of the members of a profession “

“to feel and act accordingly“

In this sport, we depend upon human beings to decide fairly on scores and placings. It is much easier to accept the time on a stopwatch, or a ball being shot into a goal.

The most significant factors in Artistic Swimming Judging are Respect, Responsibility and Integrity.

- Being fair, honest and impartial in all dealings and decisions concerning the participants in the Sport, particularly the athletes.
- Being knowledgeable about FINA Rules, and applying them fairly.
- Awareness of external pressures, from club, country, Federation, NOC, and being resistant to these influencing scores.
- Awareness of all possible Bias factors – positive, negative, country, continental, and personal.
- Avoiding discussion of athlete performances until the competition is completed.
- Willing to provide constructive feedback to coaches.
- Exchanging gifts only after the completion of the competition
- Conforming to acceptable dress codes.

As well as with Judging, there are other Ethical considerations within the sport.

- The basics of human lifestyle, and the building of a respective theory.
- The review and the evaluation of norms and values.
- What is right, what is questionable and what is not allowed.
- What affects our decisions, and the freedom in making decisions.

Ethical Considerations of and for other groups:

- Coaches:
 - Respect athletes, psychologically and physically
 - Accept rules and training schedules
 - Respect creativity and avoid copying choreography



- Team Managers:
 - Fairness first /share the pool
 - Cooperate with organisers

- Athletes:
 - Respect fellow competitors
 - Respect rules, including Doping

- Spectators (particularly parents):
 - respect officials and all athletes

- Media and Press:
 - stay impartial and report accurately



G. FORMS

- 1. FINA Artistic Swimming Judges List Activity report**
- 2. FINA Artistic Swimming Judges List Confirmation form**
- 3. FINA Artistic Swimming Judges List Nomination form**
- 4. FINA Artistic Swimming Practice Judge Application form**
- 5. FINA Artistic Swimming Evaluation Form**

Name:

National Federation Code:

Please return this form completed for each judge that you are **reconfirming**.
Please fill in the name of the judge and the country code at the top of each form.

National Federation:

Full Name	Country Code

Judge:

Family Name(s):			
First Name(s)			
Date of Birth (dd,mm,yyyy)		Sex (Male/Female)	
FINA List category. Please check (✓) or mark with an (x) category A or G: – For new judges please use the Nomination Form			A ____ G ____

Clinics & Schools:

Clinics Attended (FINA, Continental, Others – Dates & Place)	
FINA School (Dates & Place)	Test Result:

Judging Activity:

National Activities	Yes	No
International Activities (Name of the Competition / Dates / Place)		

Name:

National Federation Code:

Conflict of Interest:

- The judge has no conflict of interest. _____ (please confirm with a checkmark (v) or with an (x))
 - The conflict is as follows: (provide age group, event/s and specifics of conflict:
-

Conflict of Interest:

The following categories of people are deemed to have a conflict of interest:

- a) a Relative of a Competitor
- b) a current Coach of a Competitor or Relative of a current Coach of a Competitor
This does not apply to local competitions.
- c) a Team Manager or Relative of a Team Manager
- d) an inhabitant of the same household of the Competitor and any of a), b) c)

"Relative" refers to a person connected with another by blood or marriage (including boyfriend and/or girlfriend). Relative also includes step relationships and is any of parent, child, sibling, uncle, aunt, nephew, niece, first cousin, grandparent or spouse. "Coach" refers to any person who coaches figures and/or routines on a regular basis to the Competitor.

Judges must observe FINA Code of Ethics Section F (Conflict of Interest) and if a judge neglects to declare a situation of a potential conflict of interest, the FINA President or one of the FINA Executive members may refer the matter to the Ethics Panel.

Signed by the Federation President/General Secretary:

Stamp of National Federation:



FINA ARTISTIC SWIMMING JUDGES LIST – NEW JUDGE NOMINATION

Name:

National Federation Code:

One form per judge – Please fill in by computer or in capital letters

National Federation:

Full Name	Country Code

Judge:

Family Name(s):			
First Name(s)			
Date of Birth (dd,mm,yyyy)		Sex (Male/Female)	

Training:

National Courses attended (FINA, Continental, Others – Dates & Place)
FINA Clinics attended (Dates & Place)
FINA Schools attended (Dates & Place)

Judging Experience:

National Competitions (Minimum 2 years)
International Competitions

Conflict of Interest:

- The judge has no conflict of interest. _____ (please confirm with a checkmark (v) or (x))
 - The conflict is as follows: (provide age group, event/s and specifics of conflict:
-

Conflict of Interest:

The following categories of people are deemed to have a conflict of interest:

- a) a Relative of a Competitor
- b) a current Coach of a Competitor or Relative of a current Coach of a Competitor
This does not apply to local competitions.
- c) a Team Manager or Relative of a Team Manager
- d) an inhabitant of the same household of the Competitor and any of a), b) c)

"Relative" refers to a person connected with another by blood or marriage (including boyfriend and/or girlfriend). Relative also includes step relationships and is any of parent, child, sibling, uncle, aunt, nephew, niece, first cousin, grandparent or spouse. "Coach" refers to any person who coaches figures and/or routines on a regular basis to the Competitor.

Judges must observe FINA Code of Ethics Section F (Conflict of Interest) and if a judge neglects to declare a situation of a potential conflict of interest, the FINA President or one of the FINA Executive members may refer the matter to the Ethics Panel.

Signed by the Federation President/General Secretary:

Stamp of National Federation:



2017 – 2021 Practice Judging Form

One form per judge – Please fill in by computer or in capital letters

PRACTICE JUDGING FORM

Any judge wishing to practice judge must **not** have a **conflict of interest**. The following categories of people are deemed to have a conflict of interest:

- a) a Relative of a Competitor
- b) a current Coach of a Competitor or Relative of a current Coach of a Competitor
This does not apply to local competitions.
- c) a Team Manager or Relative of a Team Manager
- d) an inhabitant of the same household of the Competitor and any of a), b) c)

"Relative" refers to a person connected with another by blood or marriage (including boyfriend and/or girlfriend). Relative also includes step relationships and is any of parent, child, sibling, uncle, aunt, nephew, niece, first cousin, grandparent or spouse. "Coach" refers to any person who coaches figures and/or routines on a regular basis to the Competitor.

Judges must observe FINA Code of Ethics Section F (Conflict of Interest) and if a judge neglects to declare a situation of a potential conflict of interest, the FINA President or one of the FINA Executive members may refer the matter to the Ethics Panel.

The judge has no conflict of interest: _____ (please confirm with a checkmark (✓) or an (x))
The conflict is as follows: (provide age group, event/s and specifics of conflict):

National Federation:

Full Name	Country Code

Judge to be included in the shadow panel:

Family Name(s):			
First Name(s)			
FINA list category (A, G)		Since: (year)	
Number of FINA evaluations:			

Competition:

Title:	
Dates and place:	

FINA Artistic Swimming Judges School:

Dates/Place	Exam Result

Signed by the Federation President/General Secretary:

Date:

Signature:

Applications must be returned to the FINA Office **60 days prior to the Competition**

Email: artisticswimming@fina.org / Fax: (41-21) 312 66 10

ARTISTIC SWIMMING COMPETITION FREE ROUTINES

This form must be sent to the FINA Data Base Manager within 60 days

EVALUATION PER JUDGE

(Summary of evaluations, use one form per judge)

Name of Judge Federation Qualification : A G Other :
 Competition Place
 Date Observer

Item	S, D, T, C, H	S, D, T, C, H	S, D, T, C, H	S, D, T, C, H	S, D, T, C, H	S, D, T, C, H	S, D, T, C, H	S, D, T, C, H
	Free	Free	Free	Free	Free	Free	Free	Free
	Prelim / Final	Prelim / Final	Prelim / Final	Prelim / Final	Prelim / Final	Prelim / Final	Prelim / Final	Prelim / Final
	EX, AI, DIF	EX, AI, DIF	EX, AI, DIF	EX, AI, DIF	EX, AI, DIF	EX, AI, DIF	EX, AI, DIF	EX, AI, DIF
Number of Participants:								
Places performance in correct score range	5 4 3 2 1	5 4 3 2 1	5 4 3 2 1	5 4 3 2 1	5 4 3 2 1	5 4 3 2 1	5 4 3 2 1	5 4 3 2 1
Recognizes performances of equal level	5 4 3 2 1	5 4 3 2 1	5 4 3 2 1	5 4 3 2 1	5 4 3 2 1	5 4 3 2 1	5 4 3 2 1	5 4 3 2 1
Placing top swimmers	5 4 3 2 1	5 4 3 2 1	5 4 3 2 1	5 4 3 2 1	5 4 3 2 1	5 4 3 2 1	5 4 3 2 1	5 4 3 2 1
Placing middle swimmers	5 4 3 2 1	5 4 3 2 1	5 4 3 2 1	5 4 3 2 1	5 4 3 2 1	5 4 3 2 1	5 4 3 2 1	5 4 3 2 1
Placing lowest swimmers	5 4 3 2 1	5 4 3 2 1	5 4 3 2 1	5 4 3 2 1	5 4 3 2 1	5 4 3 2 1	5 4 3 2 1	5 4 3 2 1
Consider: Ties	5 4 3 2 1	5 4 3 2 1	5 4 3 2 1	5 4 3 2 1	5 4 3 2 1	5 4 3 2 1	5 4 3 2 1	5 4 3 2 1
Consider: Total Deviation	5 4 3 2 1	5 4 3 2 1	5 4 3 2 1	5 4 3 2 1	5 4 3 2 1	5 4 3 2 1	5 4 3 2 1	5 4 3 2 1
EVALUATION: general judging	5 4 3 2 1	5 4 3 2 1	5 4 3 2 1	5 4 3 2 1	5 4 3 2 1	5 4 3 2 1	5 4 3 2 1	5 4 3 2 1
EVALUATION: re no bias	3 2 1	3 2 1	3 2 1	3 2 1	3 2 1	3 2 1	3 2 1	3 2 1
General comments on: Independence, promptness, professionalism, concentration etc.								

5 Very good | 4 = Good | 3 = Satisfactory | 2 = Deficient| 1 = Weak
 3 Good | 2 -Acceptable | 1 Unacceptable

Overall evaluation for this competition:	5 4 3 2 1
Overall evaluation related to no bias:	3 2 1

Date: _____

Signature: _____

ARTISTIC SWIMMING COMPETITION TECHNICAL ROUTINES AND FIGURES

This form must be sent to the FINA Data Base Manager within 60 days

EVALUATION PER JUDGE

(Summary of evaluations, use one form per judge)

Name of Judge Federation Qualification : A, G, Other :
 Competition Place
 Date Observer.....

Item	S, D, T, FIG	S, D, T, FIG	S, D, T, FIG	S, D, T, FIG	S, D, T, FIG	S, D, T, FIG	S, D, T, FIG	S, D, T, FIG
	Tech	Tech	Tech	Tech	Tech	Tech	Tech	Tech
	Prelim / Final	Prelim / Final	Prelim / Final	Prelim / Final	Prelim / Final	Prelim / Final	Prelim / Final	Prelim / Final
	EX, IMP, ELE	EX, IMP, ELE	EX, IMP, ELE	EX, IMP, ELE	EX, IMP, ELE	EX, IMP, ELE	EX, IMP, ELE	EX, IMP, ELE
Number of Participants:								
Places performance in correct score range	5 4 3 2 1	5 4 3 2 1	5 4 3 2 1	5 4 3 2 1	5 4 3 2 1	5 4 3 2 1	5 4 3 2 1	5 4 3 2 1
Recognizes performances of equal level	5 4 3 2 1	5 4 3 2 1	5 4 3 2 1	5 4 3 2 1	5 4 3 2 1	5 4 3 2 1	5 4 3 2 1	5 4 3 2 1
Placing top swimmers	5 4 3 2 1	5 4 3 2 1	5 4 3 2 1	5 4 3 2 1	5 4 3 2 1	5 4 3 2 1	5 4 3 2 1	5 4 3 2 1
Placing middle swimmers	5 4 3 2 1	5 4 3 2 1	5 4 3 2 1	5 4 3 2 1	5 4 3 2 1	5 4 3 2 1	5 4 3 2 1	5 4 3 2 1
Placing lowest swimmers	5 4 3 2 1	5 4 3 2 1	5 4 3 2 1	5 4 3 2 1	5 4 3 2 1	5 4 3 2 1	5 4 3 2 1	5 4 3 2 1
Consider: Ties	5 4 3 2 1	5 4 3 2 1	5 4 3 2 1	5 4 3 2 1	5 4 3 2 1	5 4 3 2 1	5 4 3 2 1	5 4 3 2 1
Consider: Total Deviation	5 4 3 2 1	5 4 3 2 1	5 4 3 2 1	5 4 3 2 1	5 4 3 2 1	5 4 3 2 1	5 4 3 2 1	5 4 3 2 1
EVALUATION: general judging	5 4 3 2 1	5 4 3 2 1	5 4 3 2 1	5 4 3 2 1	5 4 3 2 1	5 4 3 2 1	5 4 3 2 1	5 4 3 2 1
EVALUATION: re no bias	3 2 1	3 2 1	3 2 1	3 2 1	3 2 1	3 2 1	3 2 1	3 2 1
General comments on: Independence, promptness, professionalism, concentration etc.								

5 Very good | 4 = Good | 3 = Satisfactory | 2 = Deficient| 1 = Weak

3 Good | 2 -Acceptable | 1 Unacceptable

Overall evaluation for this competition:	5 4 3 2 1
Overall evaluation related to no bias:	3 2 1

Date: _____ Signature: _____



SECTION II

FIGURES



A. JUDGING FIGURES

A figure is a combination of basic body positions and transitions, performed in a manner and order as prescribed by the FINA Handbook rule descriptions.

1. FINA RULES FOR JUDGEMENT OF FIGURES

AS 10 – JUDGEMENT OF FIGURES

AS 10.1 The competitor can obtain points from 0 – 10 using 1/10th points.

Perfect	10	Satisfactory	5.9 – 5.0
Near perfect	9.9 – 9.5	Deficient	4.9 – 4.0
Excellent	9.4 – 9.0	Weak	3.9 – 3.0
Very Good	8.9 – 8.0	Very weak	2.9 – 2.0
Good	7.9 – 7.0	Hardly recognisable	1.9 – 0.1
Competent	6.9 – 6.0	Completely failed	0

AS 10.2 All judgements are made from the standpoint of perfection with each transition of the figure having a numerical value based on its difficulty (NVT). Large, medium and small deductions shall be taken from the percent value of ten (PV) of each figure as follows.

AS 10.2.1 SMALL DEDUCTION

Deduction 0.1 - 0.5 points. A small deduction shall be taken when the transition follows the description of the figure with minimal deviations of 1-15 degrees.

AS 10.2.2 MEDIUM DEDUCTION

Deduction 0.6 - 1.5 points. A medium deduction shall be taken when an attempt is made to follow the description of the transition but there are some obvious deviations of 16-30 degrees.

AS 10.2.3 LARGE DEDUCTION

Deduction 1.6 - 3.0 points. A large deduction shall be taken when the transition does not conform to the description by 31 degrees or more.

AS 10.2.4 Deductions for excessive travel or lack of required travel in any transition shall not exceed 0.5.

NOTE: A deduction may not exceed the PV of the respective transition.

AS 10.3 If any judge for any reason has made no award for any one figure, the average of the awards of the other judges shall be computed and shall be considered as that of the missing award. This shall be calculated to the nearest 0.1 point.



APPENDIX IV - RULES FOR FIGURES

Unless otherwise specified in the description, figures shall be executed high and controlled, in uniform motion, with each section clearly defined.

All judgements are made from the standpoint of perfection

DESIGN

Consider: the accuracy of positions and transitions as specified in the figure description.

CONTROL

Consider: extension, height, stability, clarity, uniform motion, unless otherwise specified in the figure description.

Figures are executed in a stationary position (unless otherwise specified in the figure description).

Notes:

1. Figures are defined in terms of their component parts: body positions and transitions. Refer to Appendix II for body position requirements, and Appendix III for descriptions of common basic movements.
2. A transition is a continuous movement from one position to another. The completion of a transition should occur simultaneously with the achievement of body position and desired height. Except where otherwise specified, water level remains constant during a transition.
3. Unless otherwise specified in the figure description, maximum height is desirable at all times. Height is evaluated based on the water level of body parts.
4. Unless otherwise specified in the figure description, figures are executed in a stationary position. Transitions which allow some movement will be marked with an arrow in the diagram.
5. Diagrams are a guide only. If there is discrepancy between a diagram and a written description, the English written version of the FINA Handbook shall prevail.
6. During the execution of a figure, a pause may occur only in those positions which are printed in "**bold type**" and defined in Appendix II.
7. Basic movements are described only once, in Appendix III, and are "*italicized*" when referred to in a figure description.
8. When "and" is used to connect two actions, it means one follows the other; when "as" is used, it means both actions occur simultaneously.
9. Arm/hand positions and actions are optional.
10. When "rapid" or "rapidly" is used in a description, it shall apply specifically to the tempo of the transition in which it is included, and not to the entire figure.



2. GUIDELINE FOR FIGURE JUDGING

Figures are a combination of Body Positions and Body Movements. The numerical value of each transition is based on the difficulty that is shown in the assigned difficulty as per the manual. To be able to judge correctly you must have in mind the following:

1. **Design** - that portion of the figure award attributed to evaluation of the degree of conformation to those positions and movements specified in the figure description.

Specific design factors - accuracy of all body positions and transitions

- a. accuracy of the lines, angles, arches and circles

Examples:

- a) a **Ballet Leg position** is perpendicular to the surface
- b) a **Fishtail position** has the foot of the extended leg at the surface
- c) in a Dolphin, the body must describe a circle

- b. accuracy of alignment of body parts

Examples:

- a) in **Vertical positions**, alignment of ear, shoulder joint, hip joint and ankle bone
- b) in a **Split position**, vertical alignment of head, shoulder and hip joints; and horizontal alignment of hip and shoulder joints with the two horizontal lines 'square' and parallel to one another.

- c. correctness of pikes and tucks

Examples:

- a) 90° angle in **Front Pike position**
- b) **Back Pike position** 45° angle or less, with legs and trunk extended
- c) **Tuck positions** as compact as possible

- d. accuracy of transitional movements

Examples:

- a) in *assuming a Front Pike Position*, the hips replace the head at the surface
- b) in *Arch to Back Layout Finish Action and Walkouts*, head replaces hips at the surface
- c) in a *Combined Spin*, the *ascending* and *descending spins* must have the same number of revolutions

2. **Control** - that portion of the figure award attributed to the evaluation of how well a performance achieves the control factors. The control factor is the use of strength and coordination to demonstrate mastery of figure execution.



Control in figures is the ability to:

- maintain stable correct positions
- move the body smoothly, accurately and effortlessly through the required transitions
- remain 'on-the-spot' unless otherwise specified in the description
- give an overall impression of ease of performance.

Specific control factors:

- a. Extension - of total body throughout the figure, unless otherwise specified.
- b. Sustained maximum height - of body parts in relation to the water surface, unless otherwise specified in the figure description.
- c. Uniform motion - constant speed of action throughout the figure, unless otherwise specified in the figure description.

There shall be constant speed of action through each transitional movement. This does not mean that every transition takes the same amount of time, as it depends on the range of movement required. Transitions are to be executed without any pauses or stops therein.

Judging emphasis is placed on controlled uniformity of performance speed, not slowness.

When the rule requires a tempo change during one or more parts of a figure, the change(s) must conform to the tempo(s) specified.

When the rule requires 'rapid' or 'rapidly' movement in the figure, it should be obviously visible more speed than all non-rapid actions.

- d. Stationary - 'on-the-spot', with no travelling, except for movement specified in a figure description.
- e. Stability - solid, with equilibrium maintained and unaffected by change of position.
- f. Clarity - clear definition between positions and directions, continuous course of action in the transitions.

Transitions proceed through the most direct and accurate course of action. When the transition is finished, there should be a slight pause - as a 'comma', not a 'period' - to define the position and completion of the transition, before the next transition begins.

- g. Ease of performance - overall impression. Appearance of total confidence and effortless, fluid execution without evidence of strain.

Although FINA rules do not specify the use of Design and Control when assigning scores for figures, it is useful for training judges.

After considering all this you make the deductions according to **AS10.2.1 – AS10.2.4**



3. DEDUCTION GUIDELINE FOR FIGURES

3.1 Visible scales of angle deviation

Small Deviation 1 – 15 degrees
 Medium Deviation 16 – 30 degrees
 Large Deviation 31 degrees or more

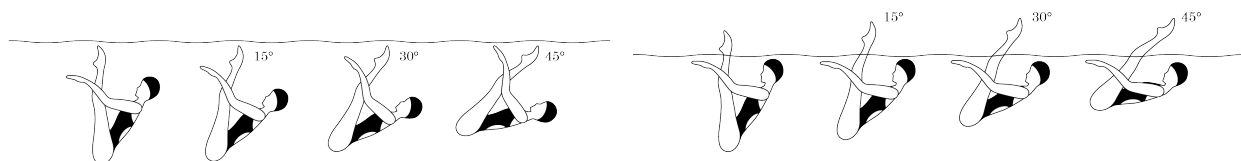
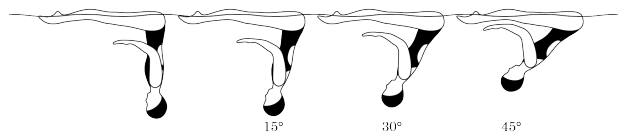
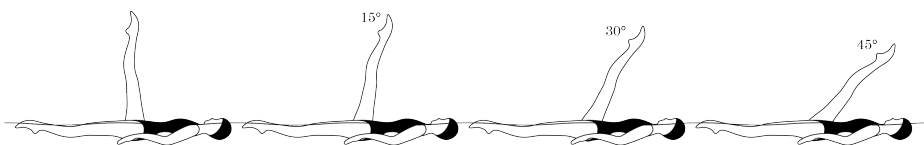
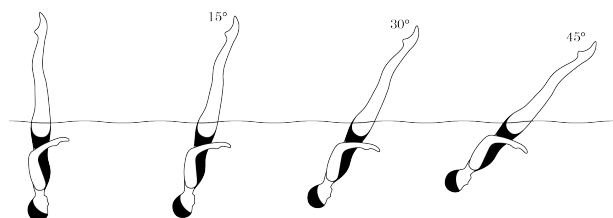
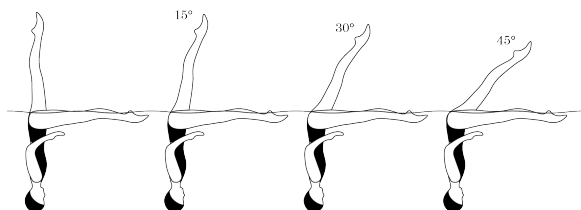
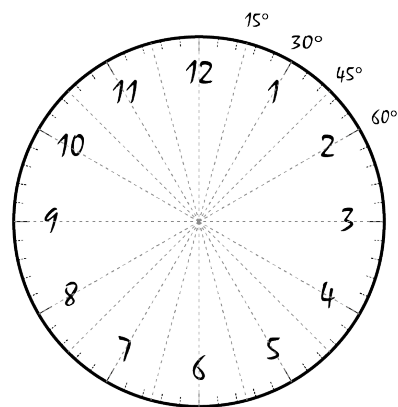



3.2 Deduction guidelines for Senior and Junior Figures

The deduction guidelines for Senior and Junior Figures, Age Group 13-14-15 Figures, and Age Group 12 and Under Figures 2017-2021 are shown as follows.

Figure / transition	Small Deviation 0.1 – 0.5 1 – 15 degrees	Medium Deviation 0.6 – 1.5 16 – 30 degrees	Large Deviation 1.6 – 3.0 31 degrees or more
---------------------	--	--	--

Barracuda Airborne Split Spin up 360

<i>Back Layout Position to Back Pike Position</i>	Legs up to 15 degrees from perpendicular	Legs 16 to 30 degrees from perpendicular	Legs 31 degrees or more from perpendicular
	Angle between legs and trunk 46-60 degrees	Angle between legs and trunk 61-75 degrees	Angle between legs and trunk more than 75 degrees
<i>Thrust</i>	Legs up to 15 degrees from perpendicular	Legs 16 to 30 degrees from perpendicular	Legs 30 degrees or more from perpendicular
<i>Vertical to Split to Vertical</i> (<i>Split position</i>)	Torso/body forward/backward up to 15 degrees from perpendicular in split position	Torso/body forward/backward 16-30 degrees from perpendicular in split position	Torso/body forward/backward 31 degrees or more from perpendicular
	*See an angle chart for splits		
<i>Spin up 360</i>	Body up to 15 degrees from Perpendicular	Body between 16 and 30 degrees from Perpendicular	Body more than 30 degrees from Perpendicular

Porpoise Twist Spin

<i>Front Layout Position to Front Pike Position</i>	*Travel is as per the proposed FINA rule re deductions for travel		
	Torso and head up to 15 degrees short or beyond perpendicular	Torso and head 16-30 degrees short or beyond perpendicular	Torso and head 31 degrees or more short or beyond perpendicular
<i>Front Pike Position to Vertical Position</i>	Body up to 15 degrees from Perpendicular	Body between 16 and 30 degrees from Perpendicular	Body more than 30 degrees from Perpendicular
<i>Twist Spin</i>	Legs/Body up to 15 degrees from perpendicular	Legs/Body 16 to 30 degrees from perpendicular	Legs/Body 31 degrees or more from perpendicular

London Combined Spin 720

<i>Inverted Back Tuck Position to Vertical Position</i>	Legs/Body up to 15 degrees from Perpendicular	Legs/ Body between 16 and 30 degrees from Perpendicular	Legs/Body more than 30 degrees from Perpendicular
<i>Combined Spin</i>	Legs/Body up to 15 degrees from Perpendicular	Legs/ Body between 16 and 30 degrees from Perpendicular	Legs/Body more than 30 degrees from Perpendicular



Figure / transition	Small Deviation 0.2 – 0.5 1 – 15 degrees	Medium Deviation 0.6 – 1.5 16 – 30 degrees	Large Deviation 1.6 – 3.0 31 degrees or more
----------------------------	---	---	---

Aurora Twirl

<i>Submerged Double Ballet Leg to Knight Position</i>	Legs up to 15 degrees from perpendicular	Legs 16 to 30 degrees from perpendicular	Legs 31 degrees or more from perpendicular
<i>Twirl</i>	Legs/Body up to 15 degrees from perpendicular	Legs/Body 16 to 30 degrees from perpendicular	Legs/Body 31 degrees or more from perpendicular

Whirlwind

<i>Two rapid rotations in Fishtail Position</i>	Vertical leg/Body up to 15 degrees from perpendicular	Vertical leg/Body 16 to 30 degrees from perpendicular	Vertical leg/Body 31 degrees or more from perpendicular
<i>Continuous spin 720</i>	Vertical leg/Body up to 15 degrees from perpendicular	Vertical leg/Body 16 to 30 degrees from perpendicular	Vertical leg/Body 31 degrees or more from perpendicular

Butterfly

<i>Fishtail position to Fishtail Position</i>	Leg up to 15 degrees from perpendicular	Leg 16 to 30 degrees from perpendicular	Leg 31 degrees or more from perpendicular
<i>(Split position)</i>	*See an angle chart for splits		

Kipswirl Split Closing 180

<i>Vertical Position, Vertical Descent</i>	Legs/Body up to 15 degrees from Perpendicular	Legs/ Body between 16 and 30 degrees from Perpendicular	Legs/Body more than 30 degrees from Perpendicular
--	---	---	---

Ipanema

<i>Surface Arch Position to Vertical Position</i>	Before lift, Bent Knee up to 15 degrees from perpendicular	Before lift, Bent Knee between 16 and 30 degrees from perpendicular	Before lift, Bent Knee more than 30 degrees from perpendicular
	Legs/Body up to 15 degrees from perpendicular in Vertical Position	Legs/ Body between 16 and 30 degrees from perpendicular in Vertical Position	Legs/Body more than 30 degrees from perpendicular in Vertical Position
<i>Vertical to Front Pike position And/or during the lift to Vertical</i>	Body moving forward up to 15 degrees from Perpendicular	Body moving forward between 16 and 30 degrees from Perpendicular	Body moving forward more than 30 degrees from Perpendicular



3.3 Deduction guidelines for Age Group 13-14-15 Figures

Figure / transition	Small Deviation 0.1 – 0.5 1 – 15 degrees	Medium Deviation 0.6 – 1.5 16 – 30 degrees	Large Deviation 1.6 – 3.0 31 degrees or more
---------------------	--	--	--

Rio

<i>Bent Knee Position to Ballet Leg position</i>	Leg up to 15 degrees from perpendicular	Leg 16 to 30 degrees from perpendicular	Leg 31 degrees or more from perpendicular
<i>Double Ballet Leg to Submerged Back Pike position</i>	Legs up to 15 degrees from perpendicular	Legs 16 to 30 degrees from perpendicular	Legs 31 degrees or more from perpendicular
<i>Thrust</i>	Legs up to 15 degrees from perpendicular	Legs 16 to 30 degrees from perpendicular	Legs 31 degrees or more from perpendicular
	Legs/Body up to 15 degrees from perpendicular in Vertical Position	Legs/Body 16 to 30 degrees from perpendicular in Vertical Position	Legs/Body 31 degrees or more from perpendicular in Vertical Position
<i>Spin 360</i>	Legs/Body up to 15 degrees from perpendicular	Legs/Body 16 to 30 degrees from perpendicular	Legs/Body 31 degrees or more from perpendicular

Ariana

<i>Back Layout Position to Surface Arch Position</i>	*Travel is as per the proposed FINA rule re deductions for travel		
<i>Surface Arch to Split Position</i>	Body forward up to 15 degrees from perpendicular in split position	Body forward 16-30 degrees from perpendicular in split position	Body forward 31 degrees or more from perpendicular
	Hips out of alignment 1-15 degrees from center point of horizontal axis	Hips out of alignment 16-30 degrees from center point of horizontal axis torso rotated 16-30 degrees from perpendicular	Horizontal axis between legs in split not parallel to wall, torso rotated more than 30 degrees from perpendicular
<i>Rotation from Split to Split</i>	*See an angle chart for splits		
<i>Split Position to Surface Arch Position</i>	Body forward up to 15 degrees from perpendicular in split position	Body forward 16-30 degrees from perpendicular in split position	Body forward 31 degrees or more from perpendicular
<i>Surface Arch Position to Back Layout Position</i>	*Travel is as per the proposed FINA rule re deductions for travel		



Figure / transition	Small Deviation 0.1 – 0.5 1 – 15 degrees	Medium Deviation 0.6 – 1.5 16 – 30 degrees	Large Deviation 1.6 – 3.0 31 degrees or more
----------------------------	---	---	---

Jupiter

<i>Front Layout Position to Front Pike Position</i>	*Travel is as per the proposed FINA rule re deductions for travel		
	Torso and head up to 15 degrees short or beyond perpendicular	Torso and head 16-30 degrees short or beyond perpendicular	Torso and head 31 degrees or more short or beyond perpendicular
<i>Fishtail Position to Knight Position</i>	Angle between legs closing or opening from 90 degrees less than 15 degrees	Angle between legs closing or opening from 90 degrees between 16 and 30 degrees	Angle between legs closing or opening from 90 degrees more than 30 degrees
<i>Knight position to Fishtail position</i>	Vertical leg up to 15 degrees from perpendicular	Vertical leg between 16 and 30 degrees from perpendicular	Vertical leg more than 30 degrees from perpendicular
<i>Fishtail position to Vertical position</i>	Vertical leg or body up to 15 degrees from perpendicular	Vertical leg or body 16 to 30 degrees from perpendicular	Vertical leg or body 31 degrees or more from perpendicular
<i>Vertical to submerged Vertical</i>	Legs/Body up to 15 degrees from perpendicular	Legs/Body 16 to 30 degrees from perpendicular	Legs/Body 31 degrees or more from perpendicular

Oceanea

<i>Back Layout Position to Bent Knee Surface Arch Position</i>	*Travel is as per the proposed FINA rule re deductions for travel		
<i>Surface Arch Position to Vertical Position</i>	Before lift, Bent Knee up to 15 degrees from perpendicular	Before lift, Bent Knee between 16 and 30 degrees from perpendicular	Before lift, Bent Knee more than 30 degrees from perpendicular
<i>Continuous Spin 720</i>	Legs/Body up to 15 degrees from perpendicular	Legs/Body 16 to 30 degrees from perpendicular	Legs/Body 31 degrees or more from perpendicular

Albatross ½ Twist

<i>Back Layout Position to Front Pike Position</i>	*Travel is as per the proposed FINA rule re deductions for travel		
<i>Pike Position to Vertical Bent Knee Position</i>	Body up to 15 degrees from perpendicular	Body between 16 and 30 degrees from perpendicular	Body over 31 degrees from perpendicular
<i>Twists</i>	Vertical leg up to 15 degrees from perpendicular	Vertical leg between 16 and 30 degrees from perpendicular	Vertical leg more than 30 degrees from perpendicular
<i>Vertical to submerged Vertical</i>	Legs/Body up to 15 degrees from perpendicular	Legs/Body 16 to 30 degrees from perpendicular	Legs/Body 31 degrees or more from perpendicular



Figure / transition	Small Deviation 0.1– 0.5 1 – 15 degrees	Medium Deviation 0.6 – 1.5 16 – 30 degrees	Large Deviation 1.6 – 3.0 31 degrees or more
----------------------------	--	---	---

Swordtail

<i>Bent Knee Arch to Knight Position</i>	Foot/leg up to 15 degrees from perpendicular as it is lifted to knight	Foot/leg between 16 and 30 degrees from perpendicular as it is lifted to knight	Foot/leg more than 30 degrees from perpendicular as it is lifted to knight
<i>Knight Position to Surface Arch Position</i>	Body out up to 15 degrees	Body out 16 to 30 degrees	Body out 31 degrees or more
<i>Surface Arch Position to Back Layout Position</i>	*Travel is as per the proposed FINA rule re deductions for travel		

Porpoise Continuous spin 720

<i>Front Layout Position to Front Pike Position</i>	*Travel is as per the proposed FINA rule re deductions for travel		
	Torso and head up to 15 degrees short or beyond perpendicular	Torso and head 16-30 degrees short or beyond perpendicular	Torso and head 31 degrees or more short or beyond perpendicular
<i>Front Pike Position to Vertical Position</i>	Body up to 15 degrees from Perpendicular	Body between 16 and 30 degrees from Perpendicular	Body more than 30 degrees from Perpendicular
<i>Continuous Spin</i>	Legs/Body up to 15 degrees from perpendicular	Legs/Body 16 to 30 degrees from perpendicular	Legs/Body 31 degrees or more from perpendicular

Seagull

<i>Tuck to Inverted Tuck Position</i>	Shins up to 15 degrees from Perpendicular	Shins between 16 and 30 degrees from Perpendicular	Shins more than 30 degrees from Perpendicular
	Legs/Body up to 15 degrees from perpendicular in Vertical Position	Legs/ Body between 16 and 30 degrees from perpendicular in Vertical Position	Legs/Body more than 30 degrees from perpendicular in Vertical Position
<i>Vertical Position to Split Position</i>	*See an angle chart for splits		
<i>To Vertical Position</i>	Legs/Body up to 15 degrees from Perpendicular	Legs/ Body between 16 and 30 degrees from Perpendicular	Legs/Body more than 30 degrees from Perpendicular
<i>Vertical and Vertical Descent</i>	Legs/Body up to 15 degrees from Perpendicular	Legs/ Body between 16 and 30 degrees from Perpendicular	Legs/Body more than 30 degrees from Perpendicular



3.4 Deduction guidelines for Age Group 12 and Under

Figures

Figure/ transition	Small Deviation 0.1 – 0.5 1 – 15 degrees	Medium Deviation 0.6 – 1.5 16 – 30 degrees	Large Deviation 1.6 – 3.0 31 degrees or more
--------------------	--	--	--

Straight Ballet Leg

<i>Back layout to ballet leg</i>	BL is 15 degrees short of/ or beyond perpendicular	BL is 16 - 30 degrees short of/ or beyond perpendicular	BL is 31 degrees or more. short of/ or beyond perpendicular
<i>Ballet leg to Bent Knee Back Layout Position</i>	As leg bends, thigh is 1-15 degrees from perpendicular	As leg bends, thigh is 16-30 degrees from perpendicular	As leg bends, thigh is 31 degrees or more from perpendicular

Barracuda

<i>Back Layout to submerged Back Pike Position</i>	Legs up to 15 degrees from perpendicular	Legs 16 to 30 degrees from perpendicular	Legs 31 degrees or more from perpendicular
<i>Thrust</i>	Legs up to 15 degrees from perpendicular	Legs 16 to 30 degrees from perpendicular	Legs 31 degrees or more from perpendicular
<i>Vertical position</i>	Legs/Body up to 15 degrees from perpendicular	Legs/Body 16 to 30 degrees from perpendicular	Legs/Body 31 degrees or more from perpendicular
<i>Vertical descent</i>	Legs/Body up to 15 degrees from Perpendicular	Legs/ Body between 16 and 30 degrees from Perpendicular	Legs/Body more than 30 degrees from Perpendicular

Walkover Back

<i>Dolphin start to Surface Arch Position</i>	*Travel is as per the proposed FINA rule re deductions for travel		
<i>Surface Arch Position to Split Position</i>	*See an angle chart for splits		
	Body forward up to 15 degrees from perpendicular in split position	Body forward 16-30 degrees from perpendicular in split position	Body forward 31 degrees or more from perpendicular
	Hips out of alignment 1-15 degrees from center point of horizontal axis	Hips out of alignment 16-30 degrees from center point of horizontal axis torso rotated 16-30 degrees from perpendicular	Horizontal axis between legs in split not parallel to wall, torso rotated more than 30 degrees from perpendicular
<i>Split to Front Pike Position</i>	Body forward from perpendicular up to 15 degrees during transition to pike	Body forward from perpendicular between 16 and 30 degrees during the transition to pike	Body forward from perpendicular 31 degrees or more during the transition to pike
<i>Front Pike Position to Front Layout Position</i>	*Travel is as per the proposed FINA rule re deductions for travel		



Figure/ transition	Small Deviation 0.1 – 0.5 1 – 15 degrees	Medium Deviation 0.6 – 1.5 16 – 30 degrees	Large Deviation 1.6 – 3.0 31 degrees or more
---------------------------	---	---	---

Ballerina

<i>Front Layout Position to Front Pike Position</i>	*Travel is as per the proposed FINA rule re deductions for travel		
<i>Front Layout Position to Front Pike Position,</i>	Torso and head up to 15 degrees short or beyond perpendicular	Torso and head 16-30 degrees short or beyond perpendicular	Torso and head 31 degrees or more short or beyond perpendicular
<i>Front Pike to Submerged Ballet Leg Double</i>	Pike is up to 15 degrees off	Pike is 16 - 30 degrees off	Pike is 31 degrees or more off
<i>Submerged Double Ballet Leg Position to Submerged Flamingo Position</i>	As one leg is lowered to Submerged Flamingo Position vertical leg up to 15 degrees short or beyond perpendicular or leg is perpendicular and torso is up to 15 degrees short of or beyond horizontal	As one leg is lowered to Submerged Flamingo Position vertical leg up to 16-30 degrees short or beyond perpendicular or leg is perpendicular and torso is up to 16-30 degrees short of or beyond horizontal	As one leg is lowered to Submerged Flamingo Position vertical leg is 31 degrees or more short or beyond perpendicular or leg is perpendicular and torso is 31 degrees or more short of or beyond horizontal
<i>Submerged Flamingo Position to Surface Flamingo Position</i>	Torso is 75 - 89 degrees from perpendicular leg	Torso is 60-74 degrees from perpendicular leg	Torso is 60 degrees or tighter from perpendicular leg
	BL is 15 degrees short of/or beyond perpendicular	BL is 16 - 30 degrees short of/ or beyond perpendicular	BL is 31 degrees or more. short of/or beyond perpendicular
<i>Surface Flamingo Position to Bent Knee Back layout Position</i>	BK position, thigh is 1-15 degrees from perpendicular	BK position, thigh is 16-30 degrees from perpendicular	BK position, thigh is 31 degrees or more from perpendicular

Kip

<i>Tuck to Inverted Tuck Position</i>	Shins up to 15 degrees short or beyond perpendicular	Shins 16-30 degrees short or beyond perpendicular	Shins 31degrees or more short or beyond perpendicular
<i>Inverted Back Tuck position to Vertical Position</i>	Legs/Body up to 15 degrees from Perpendicular	Legs/ Body between 16 and 30 degrees from Perpendicular	Legs/Body more than 30 degrees from Perpendicular
<i>Vertical and Vertical Descent</i>	Legs/Body up to 15 degrees from Perpendicular	Legs/ Body between 16 and 30 degrees from Perpendicular	Legs/Body more than 30 degrees from Perpendicular



Figure/ transition	Small Deviation 0.1 – 0.5 1 – 15 degrees	Medium Deviation 0.6 – 1.5 16 – 30 degrees	Large Deviation 1.6 – 3.0 31 degrees or more
---------------------------	---	---	---

Swordfish

<i>Surface Arch Bent Knee Position</i>	Bent Knee (thigh) up to 15 degrees from perpendicular	Bent Knee (thigh) between 16 and 30 degrees from perpendicular	Bent Knee (thigh) more than 30 degrees from perpendicular
<i>Surface Arch Position to Back Layout Position</i>	*Travel is as per the proposed FINA rule re deductions for travel		

Swan

<i>Back Layout to Bent Knee Surface Arch Position</i>	*Travel is as per the proposed FINA rule re deductions for travel		
<i>Bent Knee Surface Arch to Knight Position</i>	Vertical leg/Body up to 15 degrees short or beyond perpendicular	Vertical leg/Body up to 16 - 30 degrees short or beyond perpendicular	Vertical leg/Body 31 degrees or more short or beyond perpendicular
<i>Rotation from Knight Position to Fishtail Position</i>	Torso and/or leg arched or piked up to 15 degrees from perpendicular	Torso and/or leg arched or piked 16-30 degrees from perpendicular	Torso and/or leg arched or piked 31 degrees or more from perpendicular
<i>Fishtail to Front Pike Position</i>	Torso arched or piked 1-15 degrees from perpendicular	Torso arched or piked 16-30 degrees from perpendicular	Torso arched or piked 31 degrees or more from perpendicular
<i>Front Pike to Front Layout Position</i>	*Travel is as per the proposed FINA rule re deductions for travel		

Water Drop

<i>Front Layout Position to Front Pike Position</i>	*Travel is as per the proposed FINA rule re deductions for travel		
	Torso and head up to 15 degrees short or beyond perpendicular	Torso and head 16-30 degrees short or beyond perpendicular	Torso and head 31 degrees or more short or beyond perpendicular
<i>Legs lifted to Bent Knee Vertical Position</i>	Vertical leg/Body up to 15 degrees from Perpendicular	Vertical leg/Body between 16 and 30 degrees from Perpendicular	Vertical leg/Body more than 30 degrees from Perpendicular
<i>180 degree Spin as bent knee extends to vertical</i>	Extended legs and body with legs up to 15 degrees short of perpendicular	Extended legs and body with legs 16 - 30 degrees short of perpendicular	Extended legs and body with legs 31 degrees or more short of perpendicular



4 BASIC PRINCIPLES OF FIGURE JUDGING

1. Plumb line points of reference are used when evaluating vertical and horizontal alignments.
2. The head always follows the alignment of the spine.
3. When initiating a transition, the swimmer never begins by reversing the specified direction of movement.
4. Unless otherwise specified by the figure description, all movements are executed so as to be equal in time and space, with simultaneous and concurrent action within transitions. All movements specified within a transition should begin from the specified starting position and be completed with the achievement of the specified final position and level.
5. Axis: - a straight line around which the body rotates.
 - a. Longitudinal axis - the lengthwise centre of the body.
 - b. Lateral axis - extending sideways from the body, either through a cross section (such as the hips), or outside the body.

During a specific figure movement, the use of the term horizontal or vertical axis specifies the relationship of the longitudinal axis to the surface of the water.

6. Height is evaluated based on the water level of body parts.



5. EXPANDED MARKING SCALE FOR FIGURES

10 Perfect	9.5 to 9.9 Near Perfect	9.0 to 9.4 Excellent	8.0 to 8.9 Very Good	7.0 to 7.9 Good	6.0 to 6.9 Competent
General Impression					
Flawless	Minute deviations from perfection.	Minor errors but none are significant.	A few minor errors.	Above average.	Average. Comfortable.
Accuracy of Positions / Stability / Ease of performance					
Total accuracy. Stable, controlled. Correct body alignment maintained throughout. Complete ease of performance.	Very precise. Stable. Minute deviations, difficult to detect.	Accurate but some may lack complete clarity. Stable.	Most positions are clear & accurate. A few very minor inaccuracies in stability and/or control.	May lack some accuracy but no major errors. Stability not maintained throughout.	Several minor inaccuracies. Not consistent. Lack of stability and control in difficult parts.
Accuracy of Transitions and Movements / Ease of performance					
Efficient and accurate course of action. Complete ease of performance.	Direct course of action. Positions 'lock into place'. Minute wavering from line of transition.	Very minor but noticeable inaccuracies in line of transition or breaks in fluidity.	Minor deviations in accuracy, efficiency &/or fluidity. Not effortless in all sections.	Obvious irregularities but none are major. Unsure and strained in parts. Effort evident in difficult parts.	Inconsistent. Problems with more difficult transitions. Effort evident throughout.
Extension / Clarity / Definition					
Precise distinction between positions and transitions, with maximum extension throughout.	Sharp. 'Show & Go'. Clear distinction between.	Deviations are few and minor. Well extended.	Accurate and clear with a few minor deviations from precision. Minor inconsistencies in extension.	Clear distinction, but not always precise. Full extension not maintained throughout.	Some obvious slurring between positions & transitions. Incomplete extension.
Height – Refer to Height Chart.					
Maximum height at all times, with level maintained as required throughout.	Almost maximum height with no level changes except as required.	Close to maximum height with minimal level changes.	High, but may lose height on most difficult transition and positions.	Above average height on easy parts with some minor level changes. Loses height on difficult transitions.	Average height. Inconsistent & changing especially in more difficult positions and transitions.
Timing / Uniform Motion / Stationary					
Smooth, uniform tempo at a comfortable speed except where required. No travel unless otherwise specified.	Minute variations in timing or position except where required. No travel unless otherwise specified.	Very minor variations in timing or position. No travel unless otherwise specified.	Timing a little bit faster or slower than as described. Not always uniform. Little if any travel.	Timing changes that are not required in the description. Strained at times. Minimal travel.	Timing may be hurried and/or uneven during uniform motion parts. Obvious travel in one or more parts.



EXPANDED MARKING SCALE FOR FIGURES - continued

5.0 to 5.9 Satisfactory	4.0 to 4.9 Deficient	3.0 to 3.9 Weak	2.0 to 2.9 Very Weak	0.1 to 1.9 Hardly Recognizable	0 Completely Failed
General Impression					
Mediocre. Significant deviations.	Problems frequent and major.	Struggling in all aspects.	Difficult to recognize.	Performance bears almost no resemblance to description.	See AS 10.1.1
Accuracy of Positions / Stability / Ease of performance					
Many minor problems. Major errors at lower end of range. Minimal control.	Most positions inaccurate with some major problems in achieving positions. Unstable.	Identifiable but very inaccurate throughout. Little control evident.	General outline present, but positions unclear. No control evident.	Complete lack of definition and control.	See AS 10.1.1
Accuracy of Transitions and Movements / Ease of performance					
Accuracy inconsistent. Some major deviations. Minimal control. Effort evident throughout.	Evident effort to meet requirements. Major errors throughout. Loses control in many parts.	Little attention to transition specifics. Many major problems in all transitions.	No attention to transition specifics.	Merely moves from one position to another.	See AS 10.1.1
Extension / Clarity / Definition					
Some attempt to define positions, but often not clear. Minimal extension.	Clarity is imprecise. Poor extension.	Unclear and poor extension throughout.	Difficult to identify a position or a transition. No extension evident.	No clarity, extension or definition throughout.	See AS 10.1.1
Height – Refer to Height Chart.					
Some height may be evident in easier sections.	Low and inconsistent. Level changes throughout.	Low. Extreme difficulty to achieve any height.	Very low. Natural buoyancy only.	No effort.	See AS 10.1.1
Timing / Uniform Motion / Stationary					
Often rushed & seldom stationary. Segmented. Obvious travel evident.	Rushed and uneven timing. Significant travel in one or more parts.	Fast and/or uneven timing. Significant travel throughout.	No apparent consideration for timing or travel requirements.	Completely lacking in correct-timing. Significant travel throughout.	See AS 10.1.1







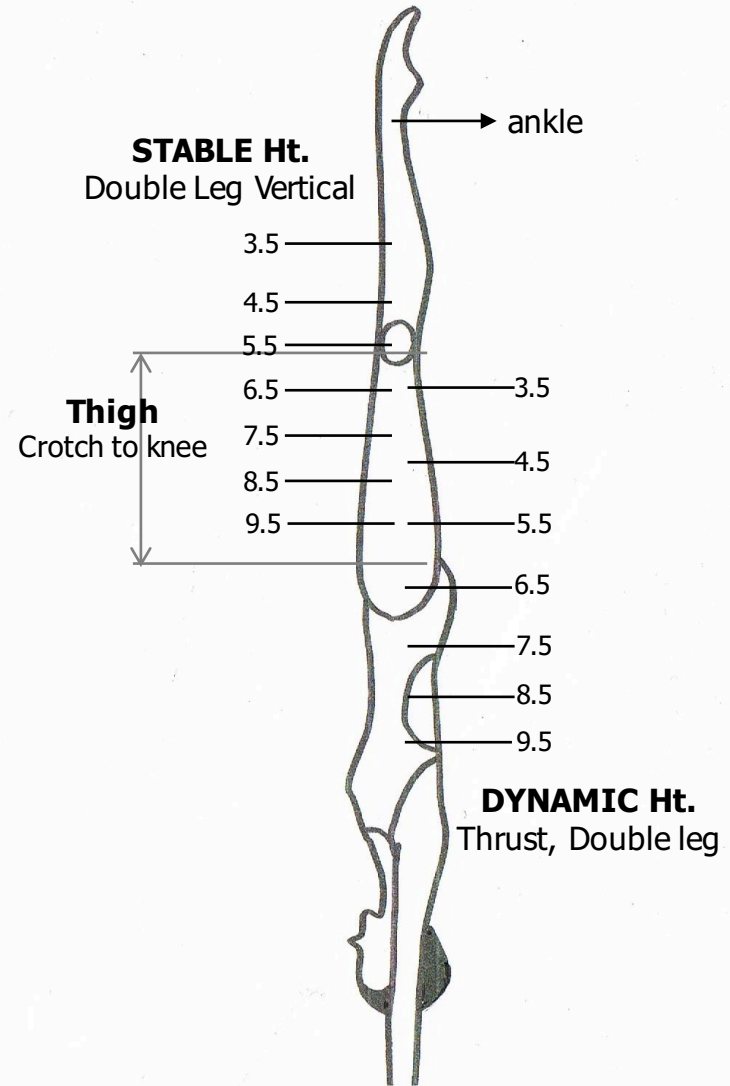
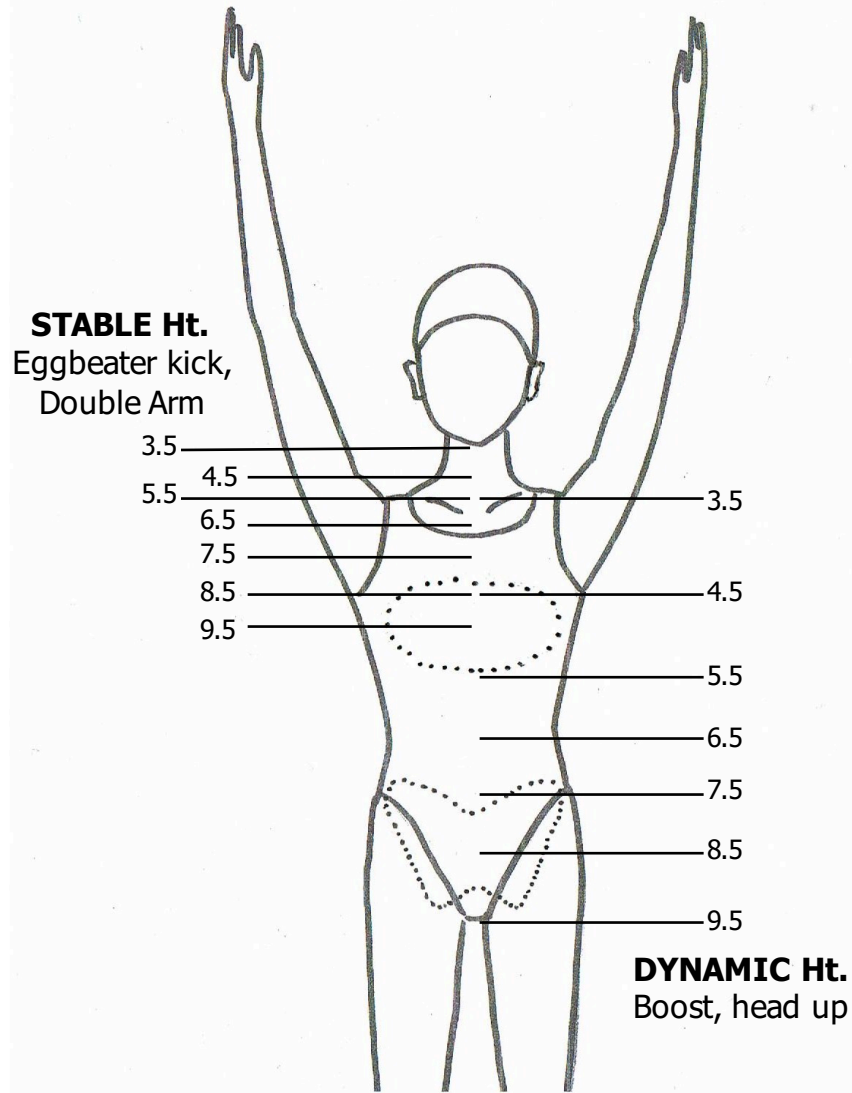







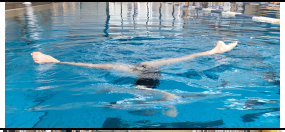

6. GUIDING SCALE FOR HEIGHT QUALITY OF PERFORMANCE TERMINOLOGY

Water Levels For:		Excellent/ Near Perfect	Very Good	Good	Competent	Satisfactory	Deficient	Weak
		9.5	8.5	7.5	6.5	5.5	4.5	3.5
Stable Height	Vertical Double Leg	Upper thigh	Upper mid thigh	Low to Mid thigh	Above knee cap	Knee cap	Below knee cap	Well below knee cap (mid shin)
	Vertical Bent Knee	Showing hips	Crotch level	Upper thigh	Mid thigh	Low thigh (Well above knee cap)	Knee cap	Below knee cap
	Fishtail	Back of horizontal leg dry	Crotch level	Upper thigh	Mid thigh	Low thigh (Well above knee cap)	Knee cap	Below knee cap
	Ballet Leg Single	At top of thigh	Upper thigh	Mid thigh	Low thigh (Well above knee cap)	Above knee cap	Knee cap	Below knee cap
	Ballet Leg Double	Mid thigh	Low thigh	Above knee cap	Knee cap	Below knee cap	Well below knee cap (mid shin)	Low to mid shin
	Eggbeater Kick Double Arm	Mid bust	Arm pit dry	Upper bust	Showing collar bone	Showing shoulder	Mid neck	Chin
	Eggbeater Kick Single Arm	Bust above surface	Mid bust	Arm pit dry	Upper bust	Showing collar bone	Showing shoulder	Mid neck
Dynamic Height	Thrust, Double Leg	Lower ribs or higher	Waist	Top of pelvis	Showing crotch	Upper thigh	Mid thigh	Above knee cap
	Thrust, Single Leg	Mid ribs	Lower ribs	Waist	Top of pelvis	Showing crotch	Upper thigh	Mid thigh
	Rocket Split, Airborne Split	Lower ribs or higher	Waist	Top of pelvis	Showing crotch	Upper thigh	Mid thigh	Above knee cap
	Boost (head up)	Crotch level or higher	Mid pelvis	Top of pelvis	Waist	Lower ribs	Arm pit	Showing shoulder

Guiding Scale for Height



. GUIDING SCALE FOR SPLIT

Score range		Angle of Split (degree)			Water level
Excellent/ Near Perfect	9.5	180 (flat)			Crotch & legs dry
Very Good	8.5	170 - 180			Legs dry
Good	7.5	160 - 170			Legs almost dry
Competent	6.5	150 - 160			lower legs dry Crotch underwater
Satisfactory	5.5	130 - 140			lower legs dry Crotch underwater
Deficient	4.5	110 - 120			feet above the surface, legs under water
Weak	3.5	up to 100			feet come out vertically
Hardly recognisable	0.1 – 2.9	scissors			feet come out vertically



B. IDENTIFYING DIFFICULTY IN FIGURES

1. IDENTIFY ESSENTIAL SYNCHRO SPECIFIC ELEMENTS

For determining degrees of difficulty, the following Essential Synchro Specific Elements (ESSE) were defined, and assigned values. The assessed values are based upon the relative difficulty of each component within a given transition.

Essential Synchro Specific Elements (ESSE)

- ① Sculling Proficiency
- ② Center of Gravity and Buoyancy
 - Relationship between Center of Gravity and Buoyancy as it affects stability
 - How the change in the relationship between the center of gravity and buoyancy affects stability
- ③ Kinesthetic and Spatial Perception
 - Kinesthetic awareness – the ability to know the spatial relationships of the body parts
- ④ Airborne Weight
- ⑤ Water Resistance
 - Resistance as created by buoyancy and/or drag
 - Formula: $\text{Drag} = 1/2 \times [\text{water density}] \times [\text{drag coefficient}] \times [\text{cross sectional area (CSA)}] \times [\text{speed of the object}]^2$
- ⑥ Joint Flexibility
 - Awarded when required action (not initial position) is beyond normal Range of Movement

2. TABLES OF TRANSITION

The following table includes the numerical values for each transition. In 2017, all transitions were reviewed and modified as required by the formula. **The difficulty of the Ad Hoc Committee on Degrees of Difficulty (2017), the Final Report shall prevail.**

1. Category 1: Airborne - Horizontal Base

1-01	Back Layout to Ballet Leg (straight)	18.5
1-02	Back Layout to Bent Knee Back Layout	10.5
1-03	Back Layout to Tub	3.0
1-04	Ballet Leg Double 360° Surface Rotation	24.0
1-05	Ballet Leg Double to Ballet Leg (straight)	24.5

1-11	Bent Knee Back Layout to Back Layout	10.5
1-12	Bent Knee Back Layout to Ballet Leg	11.0
1-13	Flamingo to Back Layout	15.0
1-14	Flamingo to Ballet Leg Double	13.0
1-15	Flamingo to Bent Knee Back Layout	15.0



1-06	Ballet Leg Double to Tub	19.0
1-07	Ballet Leg to Back Layout (straight)	18.5
1-08	Ballet Leg to Ballet Leg Double (straight)	24.5
1-09	Ballet Leg to Bent Knee Back Layout	11.0
1-10	Ballet Leg to Flamingo	13.0

1-16	Front Layout to Bent Knee Front Layout	4.0
1-17	Tub to Back Layout	3.0
1-18	Tub to Ballet Leg Double	19.0
1-19	Exchange BL	17.0
1-20	Flamingo to Ballet Leg	13.0

2. Category 2: Airborne - Vertical Base

2-01	Bent Knee Vertical (Unstable base) to Submerged Bent Knee Vertical	11.0
2-02	Bent Knee Vertical (Unstable base) to Submerged Vertical	12.0
2-03	Bent Knee Vertical to Vertical	16.5
2-04	Fishtail to Bent Knee Vertical	13.5
2-05	Fishtail to Front Pike	14.5
2-06	Fishtail to Knight	31.0
2-07	Fishtail to Knight at the surface	21.0
2-08	Fishtail to Split	15.5
2-09	Fishtail to Split (Rapid)	20.0
2-10	Fishtail to Vertical	20.5
2-11	Front Pike to Bent Knee Vertical	15.0
2-12	Front Pike to Fishtail	14.5
2-13	Front Pike to Split	20.0
2-14	Front Pike to Vertical	33.0

2-15	Vertical to Airborne Split (Unstable base)	34.0
2-16	Vertical to Airborne Split to Vertical (All bases unstable)	43.0
2-17	Vertical to Fishtail	20.5
2-18	Vertical to Fishtail to Vertical (Unstable base)	44.0
2-19	Vertical to Knight	23.5
2-20	Vertical to Split	17.0
2-21	Vertical to Split (Rapid)	17.0
2-22	Vertical to Front Pike	33.0
2-23	Vertical to Bent Knee Vertical	16.5
2-24	Vertical to Bent Knee Vertical (all Unstable base)	32.0
2-25	Bent Knee Vertical to Airborne Split (all Unstable base)	34.0
2-26	Vertical to Bent Knee to Airborne Split to Vertical (All bases unstable)	52.0
2-27	Vertical to Fishtail (all Unstable base)	34.0

3. Category 3: Arched Base or Movement

3-01	Airborne Split to Airborne Split (crossing)	52.0
3-02	Airborne Split to Vertical (Unstable base)	30.0
3-03	Airborne Split to Vertical Bent Knee (Unstable base)	31.0
3-04	Arched Bent Knee Vertical to Ballet Leg	24.5
3-05	Arched Bent Knee Vertical to Knight	20.0
3-06	Arched Fishtail to Fishtail	14.0
3-07	Back Layout to Bent Knee Surface Arch	17.5
3-08	Back Layout to Surface Arch	12.0
3-09	Ballet Leg to Knight	25.0

3-22	Knight to Bent Knee Surface Arch	15.0
3-23	Knight to Bent Knee Vertical	21.0
3-24	Knight to Fishtail (body 180° rotation)	14.0
3-25	Knight to Fishtail at surface	18.0
3-26	Knight to Split	15.5
3-27	Knight to Surface Arch	18.5
3-28	Knight to Vertical	26.5
3-29	Split to Fishtail	14.5
3-30	Split to Front Pike	19.0



3-10	Bent Knee Front Layout to Arched Bent Knee Vertical	29.0
3-11	Bent Knee Front Layout to Bent knee Surface Arch	35.0
3-12	Bent Knee Surface Arch to Bent Knee Vertical	21.0
3-13	Bent Knee Surface Arch to Surface Arch	14.5
3-14	Bent Knee Surface Arch to Vertical as Twirl is executed	29.0
3-15	Bent Knee Surface Arch to Vertical	21.0
3-16	Bent Knee Vertical to Bent Knee Surface Arch	19.0
3-17	Fishtail to Bent Knee Surface Arch (Rapid)	36.0
3-18	Front Layout to Arched Fishtail	30.5
3-19	Front Layout to Split	33.0
3-20	Front Pike to Split on surface	9.0
3-21	Knight to Ballet Leg	22.0

3-31	Split to Knight	17.5
3-32	Split to Surface Arch	23.0
3-33	Split to Vertical	20.0
3-34	Split to Vertical at Ankle Level	5.0
3-35	Surface Arch to Back Layout	8.0
3-36	Surface Arch to Knight	19.5
3-37	Surface Arch to Split	22.0
3-38	Surface Arch to Vertical	37.0
3-39	Bent Knee Surface Arch to Knight	14.0
3-40	Vertical to Surface Arch	37.0
3-41	Split to Vertical (Rapid)	16.0
3-42	Vertical to Surface Arch Bent Knee	21.0

4. Category 4: Circular Patterns

4-01	Back Layout to Dolphin First Quarter (head first)	8.0			
------	---	-----	--	--	--

5. Category 5: Descending

5-01	Back Layout to Submerged Back Pike	10.0	5-10	Vertical to Submerged Vertical	14.0
5-02	Back Layout to Submerged Ballet Leg Double	10.0	5-11	Vertical Unstable Base to Submerged Vertical	15.0
5-03	Ballet Leg Double to Submerged Ballet Leg Double	16.0	5-12	Ballet Leg Double to Submerged Back Pike	15.0
5-04	Ballet Leg to Submerged Ballet Leg	13.5	5-13	Bent Knee Vertical Unstable Base to Submerged Vertical	11.0
5-05	Bent Knee Vertical to Submerged Bent Knee Vertical	10.0	5-14	Vertical to Submerged Vertical (rapid)	13.0
5-06	Bent Knee Vertical to Submerged Vertical	11.0	5-15	Vertical Unstable Base to ankle level Vertical	15.0
5-07	Bent Knee Vertical Unstable Base to Submerged Bent Knee Vertical	11.0	5-16	Bent Knee Vertical to Submerged Bent Knee Vertical ankle level (rapid)	11.0
5-08	Vertical at Ankle Level to Submerged Vertical	5.0	5-17	Bent Knee Vertical to Submerged Bent Knee Vertical (rapid)	11.0
5-09	Vertical to Ankle Level Vertical	14.0	5-18	Bent Knee Vertical to Bent Knee Vertical ankle level	10.0



6. Category 6: Multi-dimensional

6-01	Arched Bent Knee Vertical to Submerged Flamingo	21.0
6-02	Back Layout to Front Pike (Albatross turn)	11.0
6-03	Ballet Leg to Fishtail (Catalina Rotation)	24.0
6-04	Bent Knee Surface Arch to Vertical with 360° rotation	29.5
6-05	Fishtail to Ballet Leg (Catalina Reverse Rotation)	24.0
6-06	Fishtail to Ballet Leg Double with Reverse Catalina Rotation	31.5
6-07	Front Pike to Split through Side Fishtail	23.0
6-08	Front Pike to Vertical with a Full Twist	35.0

6-09	Side Ballet Leg to Front Pike	8.0
6-10	Split through Knight variant to Bent Knee Vertical with 1/2 Twist	22.0
6-11	Split to Fishtail with rapid 180° rotation	16.5
6-12	Submerged Ballet Leg Double to Vertical with 180° rotation	19.0
6-13	Submerged Ballet Leg to Fishtail (Catalina Rotation)	14.5
6-14	Front Pike to Vertical with half twist (180° rotation - Rapid)	33.0
6-15	45° off angle Vertical to Surface Arch with 90° rotation	38.0

7. Category 7: Submerged

7-01	Submerged Ballet Leg Double to Ballet Leg Double	16.0
7-02	Submerged Ballet Leg Double to Split	11.0
7-03	Submerged Ballet Leg Double to Submerged Ballet Leg	8.0
7-04	Submerged Ballet Leg Double to Submerged Flamingo	3.0
7-05	Submerged Ballet Leg Double to Submerged Heron Pike	5.0
7-06	Submerged Ballet Leg to Ballet Leg	13.5
7-07	Submerged Bent Knee Vertical to Bent Knee Vertical	9.0
7-08	Submerged Flamingo to Ballet Leg	10.5

7-09	Submerged Flamingo to Flamingo	10.0
7-10	Submerged Vertical to Fishtail	7.5
7-11	Submerged Vertical to Submerged Back Pike	12.0
7-12	Submerged Vertical to Submerged Ballet Leg Double	10.0
7-13	Submerged Vertical to Vertical	13.0
7-14	Submerged Ballet Leg Double to Submerged Back Pike	5.0
7-15	Submerged Ballet Leg Double to Flamingo with 180 rotation	15.5
7-16	Submerged Ballet Leg Double to Flamingo with 360 rotation	18.5

8. Category 8: Rotation Lateral Axis

8-01	Back Layout to Back Pike	14.0
8-02	Back Layout to Inverted Tuck through Ballet Leg (Rapid)	16.5
8-03	Back Layout to Tuck	3.0
8-04	Back Pike "V" to Back Layout	6.0
8-05	Back Pike to "V"	13.0
8-06	Ballet Leg to Fishtail (tip)	33.0
8-07	Fishtail to Ballet Leg (tip)	33.0
8-08	Front Layout to Front Pike	6.0

8-09	Front Pike (head down) to Front Layout	6.0
8-10	Front Pike (legs down) to Front Layout	6.0
8-11	Front Pike to Submerged Ballet Leg Double	8.0
8-12	Submerged Ballet Leg Double to Front Pike (legs down)	8.0
8-13	Tuck to Back Layout	3.0
8-14	Tuck to Inverted Tuck	2.0
8-15	Tuck to Tuck	5.0
8-16	Ballet Leg to Inverted Tuck	7.0



9. Category 9

9.1: Rotation Longitudinal Axis - Twists

9.1-01	Ballet Leg to Side Ballet Leg	18.5	9.1-14	Vertical Full Twist	32.0
9.1-02	Bent Knee Vertical Full Twist	20.0	9.1-15	Vertical Half Twist	21.0
9.1-03	Bent Knee Vertical Half Twist	15.0	9.1-16	Vertical to Bent Knee Vertical with Full Twist	20.5
9.1-04	Bent Knee Vertical to Vertical with Full Twist (extending & joining)	22.0	9.1-17	Vertical to Split with Full Twist (opening 360°)	26.0
9.1-05	Bent Knee Vertical to Vertical with Half Twist (extending & joining)	16.5	9.1-18	Vertical to Split with Half Twist (opening 180°)	20.0
9.1-06	Fishtail 2 Full Twists (720° rotations - Rapid)	50.0	9.1-19	Fishtail to Vertical with 720° rotations - Rapid	37.0
9.1-07	Fishtail Half Twist	17.0	9.1-20	Fishtail to Vertical with 360° rotations - Rapid	26.5
9.1-08	Knight Full Twist	34.0	9.1-21	Split to Vertical with Full Twist (closing 360°) - Rapid	29.0
9.1-09	Knight Half Twist	24.0	9.1-22	Split to Vertical with Half Twist (closing 180°) - Rapid	18.0
9.1-10	Split Half Twist	11.0	9.1-23	Side Fishtail to 45 off angle Vertical with 180° rotations	23.5
9.1-11	Split to Split (Ariana turn)	10.0	9.1-24	45° off angle Vertical Half Twist	24.0
9.1-12	Split to Vertical with Full Twist (closing 360°)	27.0	9.1-25	Fishtail to Vertical with 180° rotations	21.5
9.1-13	Split to Vertical with Half Twist (closing 180°)	21.0	9.1-26	Vertical 2 Full Twist (720°)	54.0

9.2: Rotation Longitudinal Axis - Twirls

9.2-01	Airborne Split to Vertical with Twirl (All Bases Unstable)	27.0	9.2-06	Vertical Twirl	26.0
9.2-02	Bent Knee Vertical to Vertical with Twirl	21.5	9.2-07	Vertical Twirl - Unstable Base	36.0
9.2-03	Bent Knee Vertical Twirl	20.0	9.2-08	Vertical Twirl at Ankle	11.0
9.2-04	Split to Vertical with Twirl	22.0	9.2-09	Bent Knee Vertical Twirl (Unstable)	21.0
9.2-05	Vertical to Bent Knee Vertical with Twirl	21.0	9.2-06	Vertical Twirl	26.0

9.3: Rotation Longitudinal Axis – Descending Spins

9.3-01	Bent Knee Vertical 180° (Descending)	16.0	9.3-13	Vertical 360° (Unstable Base - Rapid)	30.0
9.3-02	Bent Knee Vertical 360° (Descending)	19.0	9.3-14	Vertical Continuous Spin 1080° (Rapid)	35.0
9.3-03	Bent Knee Vertical Continuous Spin 720° (Rapid)	27.0	9.3-15	Vertical Continuous Spin 1440° (Rapid)	39.0
9.3-04	Bent Knee Vertical Join Continuous Spin 1080° (Rapid)	28.0	9.3-16	Vertical Continuous Spin 720° (Rapid)	31.0
9.3-05	Bent Knee Vertical Join Spin 180° (Descending)	15.0	9.3-17	Vertical Continuous Spin 720° (Unstable Base - Rapid)	50.0



9.3: Rotation Longitudinal Axis – Descending Spins-cont'd

9.3-06	Bent Knee Vertical Join Spin 180° (Unstable Base - Rapid)	18.0		9.3-18	Bent Knee Vertical Join Continuous Spin 720° (Rapid)	24.0
9.3-07	Bent Knee Vertical Join Spin 360° (Descending)	16.0		9.3-19	Bent Knee Vertical 180° (Descending, Unstable Base - Rapid)	23.0
9.3-08	Fishtail to Vertical Continuous Spins 720° (Helicopter spin - Rapid)	29.5		9.3-20	Bent Knee Vertical 360° (Descending, Unstable Base - Rapid)	29.0
9.3-09	Fishtail to Vertical Spin 360° (Helicopter spin)	17.5		9.3-21	Bent Knee Vertical Continuous Spin 720° (Unstable Base - Rapid)	52.0
9.3-10	Vertical 180° (Descending)	18.0		9.3-22	Bent Knee Vertical Join Spin 360° (Unstable Base - Rapid)	24.0
9.3-11	Vertical 180° (Unstable Base - Rapid)	28.0		9.3-23	Fishtail - Bent Knee - Vertical join Spin 360° (Unstable Base - Rapid)	26.0
9.3-12	Vertical 360° (Descending)	19.0		9.3-24	Fishtail to Vertical Spin 360° (Unstable Base, rapid Helicopter spin)	25.5

9.4: Rotation Longitudinal Axis – Ascending Spins

9.4-01	Bent Knee Vertical 180° (Ascending)	14.0		9.4-04	Bent Knee Vertical Join 360° (Ascending)	16.5
9.4-02	Bent Knee Vertical 360° (Ascending)	15.0		9.4-05	Vertical 180° (Ascending)	18.0
9.4-03	Bent Knee Vertical Join 180° (Ascending)	15.5		9.4-06	Vertical 360° (Ascending)	19.0

9.5: Rotation Longitudinal Axis – Combined Actions

9.5-01	Bent Knee Combined Spin (360° + 360°)	30.0		9.5-07	Reverse Combined Spin (1080° + 1080°)	54.0
9.5-02	Bent Knee Combined Spin Joining and Bending (360° + 360°)	30.0		9.5-08	Twist Spin	48.0
9.5-03	Combined Spin (1080°+ 1080°)	54.0		9.5-09	Combined Spin (360° + 360°)(Rapid)	42.0
9.5-04	Combined Spin (360° + 360°)	38.0		9.5-10	Combined Spin (720° + 720°)(Rapid)	50.0
9.5-05	Reverse Bent Knee Combined Spin (360° + 360°)	30.0		9.5-11	Combined Spin (720° + 720°)	42.0
9.5-06	Reverse Combined Spin (360° + 360°)	38.0		9.5-12	Combined Spin (1080°+ 1080°)(Rapid)	70.0



10. Category 10: Unrolls

10-01	Ballet Leg Double to Vertical	28.0	10-07	Submerged Back Pike to Bent Knee Vertical Unstable (Thrust)	28.0
10-02	Flamingo to Bent Knee Vertical	20.0	10-08	Submerged Back Pike to Vertical Unstable (Thrust)	31.0
10-03	Flamingo to Fishtail	22.5	10-09	Submerged Ballet Leg Double to Knight (Aurora)	16.0
10-04	Inverted Tuck to Bent Knee Vertical	15.0	10-10	Submerged Ballet Leg Double to Vertical (moderate)	19.0
10-05	Inverted Tuck to Vertical	23.0	10-11	Submerged Heron Pike to Bent Knee Vertical Unstable (Thrust)	28.0
10-06	Inverted Tuck to Vertical with 360° rotation	25.0	10-12	Inverted Tuck to Vertical (Rapid)	18.0

3. Procedures for Determining Degrees of Difficulty

3.1 Determine the numerical value of each transition within a figure or an element (as shown in the above Table)

3.2 Add the NVT (Numerical Value of a Transition) of all transitions:

$$NV = \sum NVT$$

NV = numerical value of the summation of difficulties of all transitions within the figure or element

3.3 Formula:

$$DD = NV/K + C$$

K & C: constants selected to allow conversion of all NVs to DDs within a selected DD range. For the existing range of NVs (11--158), with a designated DD range from 1.1 to 3.8

$$K = 54.3$$

$$C = 0.85$$

DD = degree of difficulty of a figure or an element



4. 2017-2021 FINA FIGURE GROUPS

The figure charts in this section include a practical application for using the numerical difficulty values of each transition when judging figures.

- Line 1: figure illustrations
- Line 2: numerical difficulty value [NVT] of the transition between the preceding body position and the body position illustrated above the number.
- Line 3: proportional value [PV] of the transition out of the 10 maximum points, which may be awarded for the figure.





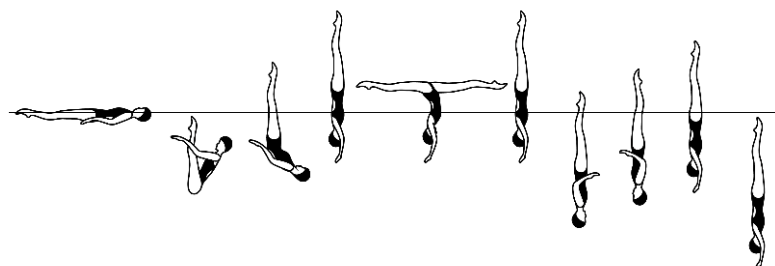

SENIOR and JUNIOR FIGURES

COMPULSORY:

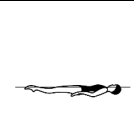
1 308i Barracuda Airborne Split, Spin Up 360° DD 3.3

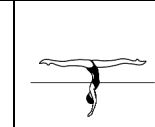
A Barracuda Airborne Split is executed to a re-joined **Vertical Position**. A *Vertical Descent* is executed at the same tempo as the *Thrust* to ankle level. The designated *Ascending Spin* is executed. A *Vertical Descent* is executed at the same tempo as the *Thrust*.

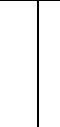



								Total
NVT=	10.0	31.0	43.0	-	15.0	19.0	13.0	131
PV =	0.76	2.37	3.28	-	1.15	1.45	0.99	

2 355g Porpoise Twist Spin DD 2.5

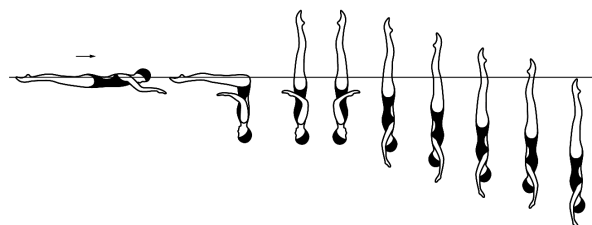
A Porpoise is executed to **Vertical Position**. A *Twist Spin* is executed.

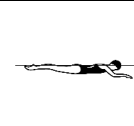

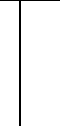
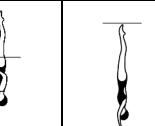
				Total
NVT=	6.0	33.0	48.0	87
PV =	0.69	3.79	5.52	





OPTIONAL GROUPS:

Group 1

3 154j-2 London Combined Spin 720° DD 2.9

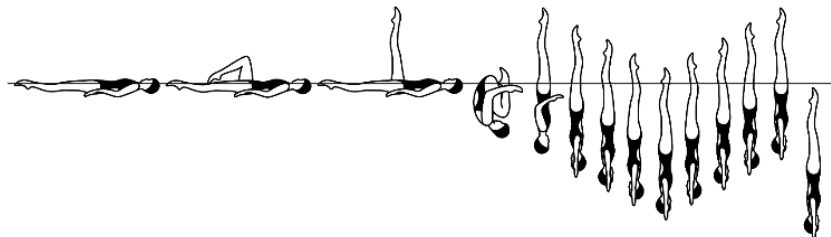
A London is executed to a **Vertical Position**. A rapid *Combined Spin of 720°* (descending spin 720° + ascending spin 720°) is executed. A rapid *Vertical Descent* is executed.

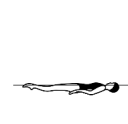

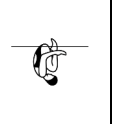
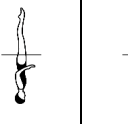
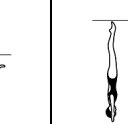
							Total
NVT=	10.5	11.0	7.0	18.0	50.0	13.0	109.5
PV =	0.96	1.00	0.64	1.64	4.57	1.19	

4 330c Aurora Twirl DD 2.8

An Aurora is executed to **Vertical Position**. A *Twirl* is executed followed by a *Vertical Descent*.

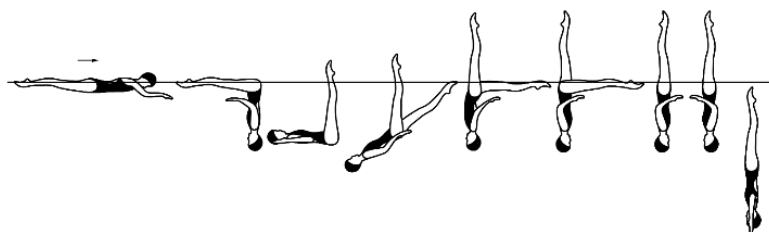

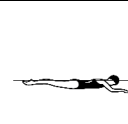
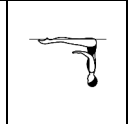
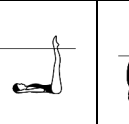
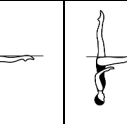
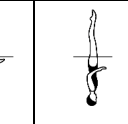
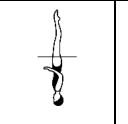
							Total
NVT=	6.0	8.0	16.0	14.0	20.5	26.0	104.5
PV =	0.57	0.77	1.53	1.34	1.96	2.49	1.34





Group 2

3 364 Whirlwind DD 2.7

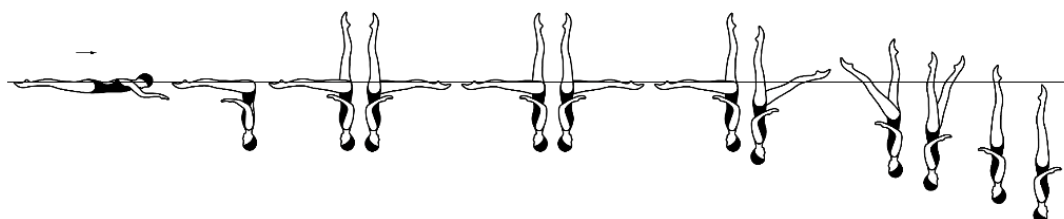
From a **Front Layout Position** a *Front Pike Position* is assumed. One leg is lifted to a **Fishtail Position**. Maintaining a **Fishtail Position**, with the horizontal leg leading toward the vertical leg, two rapid rotations (720°) are executed. Continuing in the same direction, the horizontal leg is lifted to a **Vertical Position** as a *Continuous Spin 720°* is executed.

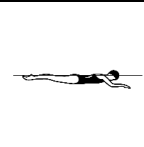

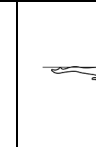
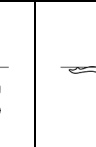
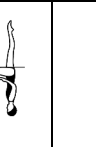
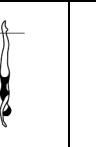

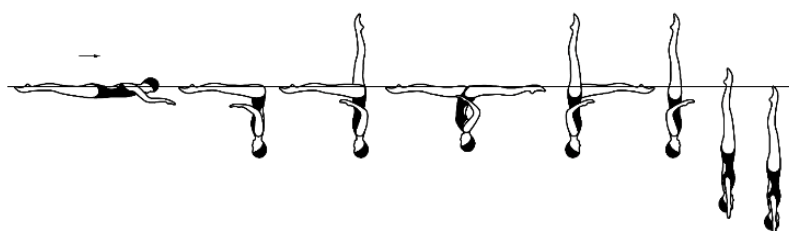

							Total
NVT=		6.0	14.5	50.0	29.5	-	100
PV =		0.60	1.45	5.00	2.95	-	

4 343 Butterfly DD 2.5

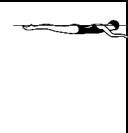
From a **Front Layout Position**, a *Front Pike Position* is assumed. One leg is lifted to a **Fishtail Position**. The horizontal leg is rapidly lifted through an arc of 180° as the vertical leg is lowered to assume a **Split Position**, without hesitating a hip rotation of 180° is executed as the front leg is raised to assume a **Fishtail Position**. The horizontal leg is lifted to a **Vertical Position** at the same tempo as the initial actions of the figure. A *Vertical Descent* is executed.

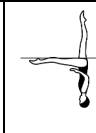

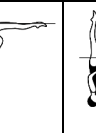
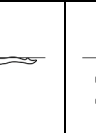
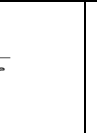
								Total
NVT=		6.0	14.5	20.0	16.5	20.5	14.0	91.5
PV =		0.66	1.58	2.19	1.80	2.24	1.53	





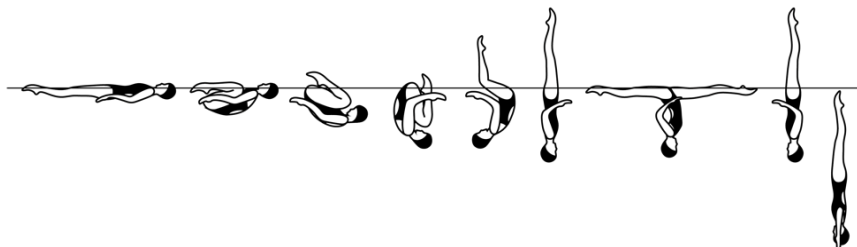

Group 3

3 320 Kipswirl Split Closing 180° DD 2.3

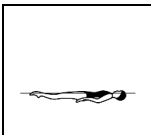
A Kipswirl is executed to the **Vertical Position**. The legs are lowered symmetrically to a **Split Position**. A rapid rotation of 180° is executed, as the legs symmetrically close to a **Vertical Position**. A *Vertical Descent* is executed.



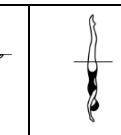

							Total
NVT=	3.0	2.0	25.0	17.0	18.0	14.0	79
PV =	0.38	0.25	3.16	2.15	2.28	1.77	

4 440 Ipanema DD 3.0

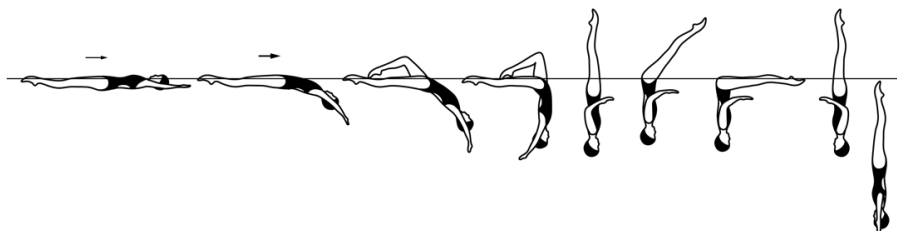
A Nova is executed to the **Bent Knee Surface Arch Position**. The horizontal leg is lifted as the bent knee is straightened to assume a **Vertical Position**. The legs are lowered to a **Front Pike Position**. A rapid 180° rotation is executed as the legs are lifted to a **Vertical Position**. A *Vertical Descent* is executed at the tempo of the rest of the figure.

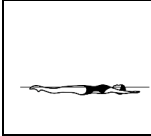

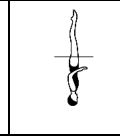
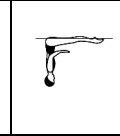
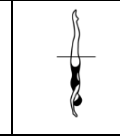
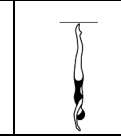
							Total
NVT=	17.5	21.0	33.0	33.0	14.0		118.5
PV =	1.48	1.77	2.78	2.78	1.18		







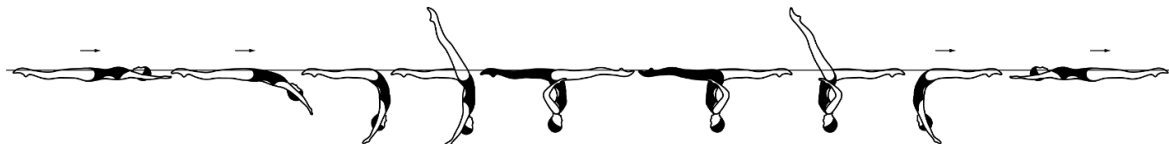

AGE GROUP 13-14-15 FIGURES

COMPULSORY:

1 423 Ariana DD 2.2

A Walkover Back is executed to a **Split Position**. Maintaining the relative position of the legs to the surface, the hips rotate 180°. A *Walkout Front* is executed.







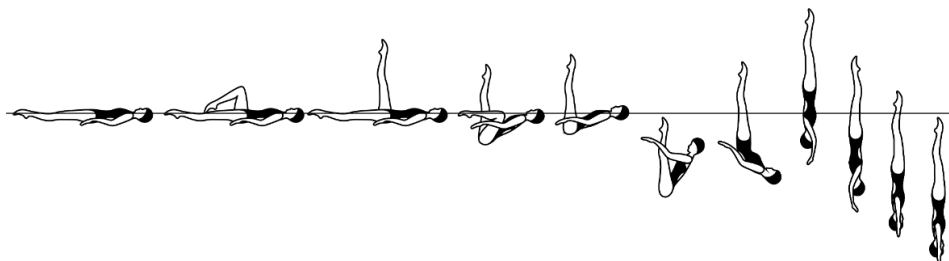

						Total
NVT=	12.0	22.0	10.0	23.0	8.0	75
PV =	1.60	2.93	1.33	3.07	1.07	

2 143 Rio DD 3.1

A **Flamingo** is executed to a **Surface Flamingo Position**. The horizontal leg is extended to a **Surface Ballet Leg Double Position**. The body submerges vertically to a **Back Pike Position** with the toes just under the surface. The figure is completed as a Barracuda Spin 360°.

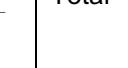

								Total
NVT=	10.5	11.0	13.0	13.0	15.0	31.0	30.0	123.5
PV =	0.85	0.89	1.05	1.05	1.21	2.51	2.43	









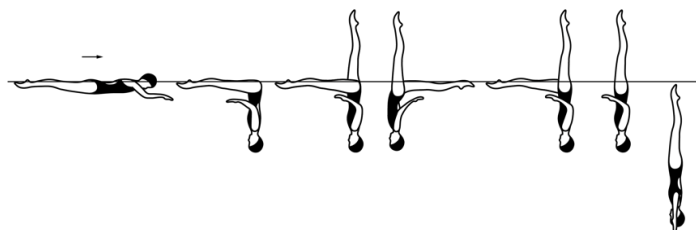

OPTIONAL GROUPS :

Group 1

3 351 Jupiter DD 2.8

A Dalecarlia is executed to a **Knight Position**. Maintaining the vertical alignment of the body, the horizontal leg is moved in a 180° arc at the surface of the water to a **Fishtail Position**. The horizontal leg is lifted to the **Vertical Position**. A *Vertical Descent* is executed.





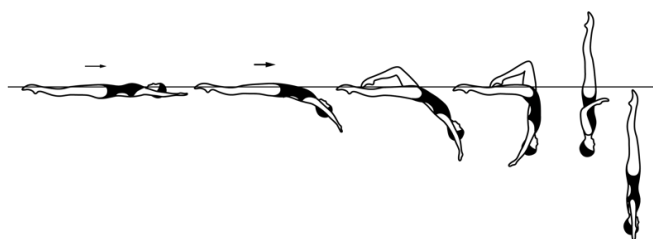

							Total
NVT=	6.0	14.5	31.0	18.0	20.5	14.0	104
PV=	0.58	1.39	2.98	1.73	1.97	1.35	

4 437 Oceanea DD 2.1

A Nova is executed to a **Bent Knee Surface Arch Position**. The horizontal leg is lifted to the vertical as the bent knee is extended to assume a **Vertical Position**. A *Continuous Spin of 720°* (2 rotations) is executed.



				Total
NVT=	17.5	21.0	31.0	69.5
PV =	2.52	3.02	4.46	





Group 2

3 240a Albatross ½ Twist DD 2.2

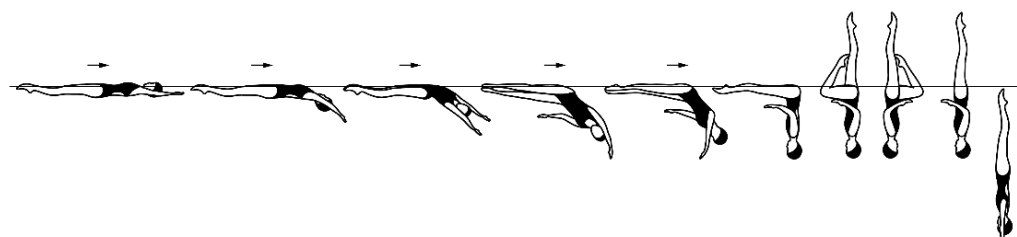
With the head leading, a *Dolphin* is initiated until the hips are about to submerge. The hips, legs and feet continue to move along the surface, as the body rolls onto the face as it assumes a **Front Pike Position**. The legs are lifted simultaneously to a **Bent Knee Vertical Position**. A *Half Twist* is executed. The designated *Twist* is executed as the bent knee is extended to meet the vertical leg. A *Vertical Descent* is executed.

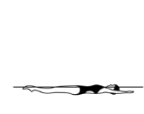
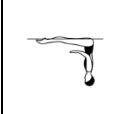

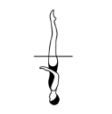
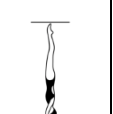

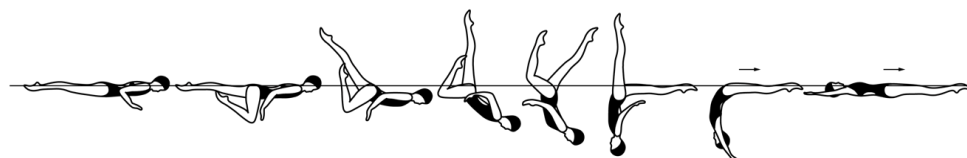

							Total
NVT=		11.0	15.0	15.0	16.5	14.0	71.5
PV =		1.54	2.10	2.10	2.31	1.96	

4 403 Swordtail DD 2.3

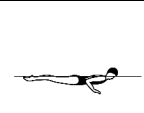
From a **Front Layout Position** the **Bent Knee Position** is assumed. The back arches more as the extended leg is lifted in an arc of 180° over the surface of the water. As the extended leg passes vertical, the bent leg straightens with the foot following a vertical line to assume a **Knights Position**. The vertical leg is lowered to a **Surface Arch Position**. An *Arch to Back Layout Finish Action* is executed.

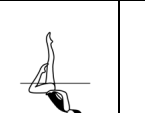

						Total	
NV=		4.0	29.0	20.0	18.5	8.0	79.5
PV =		0.50	3.65	2.52	2.33	1.01	







AGE GROUP 12 and UNDER FIGURES

COMPULSORY:

1 106 Straight Ballet Leg DD 1.6

From a **Back Layout Position**, one leg is raised straight to a **Ballet Leg Position**. The *Ballet Leg* is lowered.





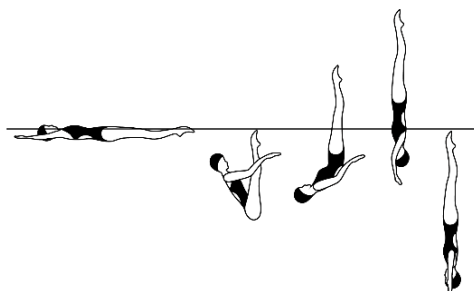

					Total
NVT=		18.5	11.0	10.5	40
PV =		4.63	2.75	2.63	

2 301 Barracuda DD 1.9

From a **Back Layout Position**, the legs are raised to a vertical as the body is submerged to a **Back Pike Position** with the toes just under the surface. A **Thrust** is executed to a **Vertical Position**. A *Vertical Descent* is executed at the same tempo as the *Thrust*.



					Total
NVT=		10.0	31.0	15.0	56
PV =		1.79	5.54	2.68	







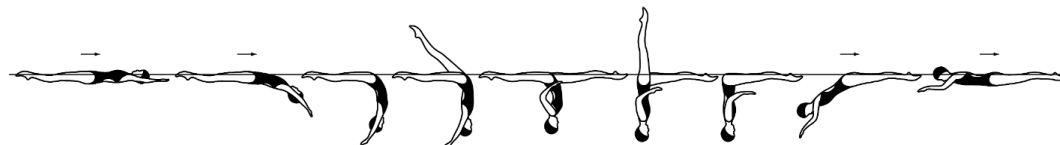

OPTIONAL GROUPS :

Group 1

3 420 Walkover Back DD 1.9

With the head leading a *Dolphin* is initiated. The hips, legs and feet continue to move along the surface as the back is arched more to assume a **Surface Arch Position**. One leg is lifted in a 180° arc over the surface to a **Split Position**. A *Walkout Back* is executed.







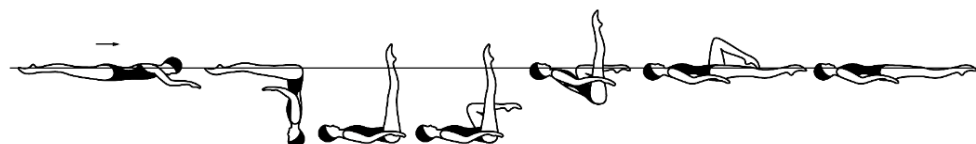

						Total
NVT=		12.0	22.0	19.0	6.0	59
PV =		2.03	3.73	3.22	1.02	

4 327 Ballerina DD 1.8

From a **Front Layout Position** a *Somersault Front Pike* is executed to a **Submerged Ballet Leg Double Position**. One knee is bent to assume a **Submerged Flamingo Position**. Maintaining this position, the body rises to a **Surface Flamingo Position**. The ballet leg is lowered in a 90° arc to the surface as the other leg moves to assume a **Bent Knee Position**. The toe moves along the inside of the extended leg until a **Back Layout Position** is assumed.



							Total
NVT=		6.0	8.0	3.0	10.0	15.0	52.5
PV =		1.14	1.52	0.57	1.90	2.86	2.00



Group 2

3 311 Kip DD 1.6

From a **Back Layout Position**, a partial Somersault Back Tuck is executed until the shins are perpendicular to the surface. The trunk unrolls as the legs are straightened to assume a **Vertical Position** midway between the former vertical line through the hips and the former vertical line through the head and the shins. A *Vertical Descent* is executed.

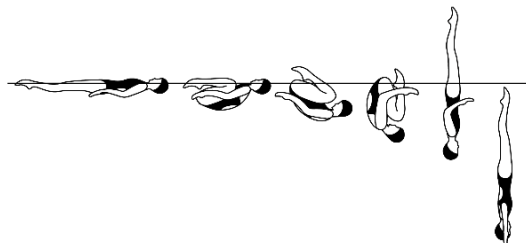

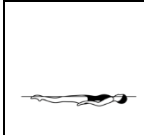
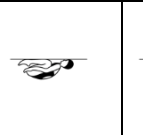
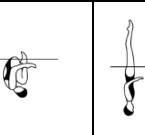
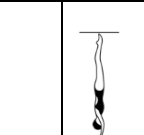
					Total
NVT=	3.0	2.0	23.0	14.0	42
PV =	0.71	0.48	5.48	3.33	

4 401 Swordfish DD 2.0

From a **Front Layout Position**, a **Bent Knee Position** is assumed. The back arches more as the extended leg is lifted in a 180° arc over the surface to assume a **Bent Knee Surface Arch Position**. The bent knee is straightened to assume a **Surface Arch Position**, and with continuous motion, an *Arch to Back Layout Finish Action* is executed.

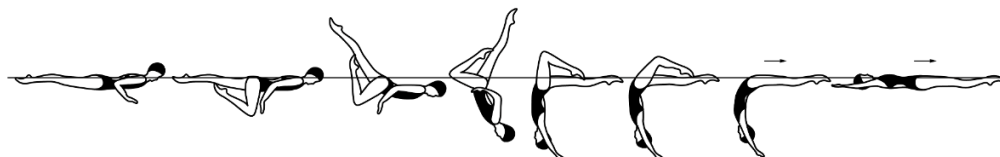

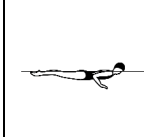
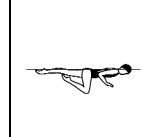
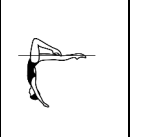
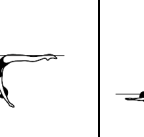
					Total
NVT=	4.0	35.0	14.5	8.0	61.5
PV =	0.65	5.69	2.36	1.30	







Group 3

3 226 Swan DD 2.1

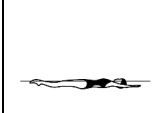
A Nova is executed to the **Bent Knee Surface Arch Position**. The bent leg straightens to assume a **Knight Position**. The body rotates 180° to assume a **Fishtail Position**. The vertical leg is lowered to the surface to meet the opposite leg in a **Front Pike Position** and with continuous movement the body straightens to a **Front Layout Position**. The head surfaces at the point occupied by the hips at the beginning of this action.

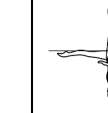
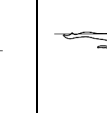



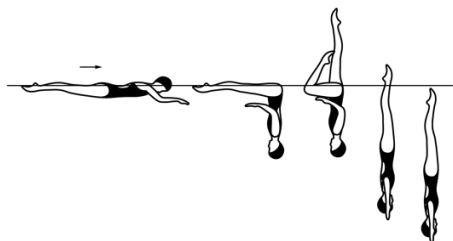

							Total
NVT=		17.5	14.0	14.0	14.5	6.0	66
PV =		2.65	2.12	2.12	2.20	0.91	

4 363 Water Drop DD 1.5

From A **Front Layout Position**, a **Front Pike Position** is assumed. The legs are lifted simultaneously to a **Bent Knee Vertical Position**. A **180° Spin** is executed as the bent knee is extended to a **Vertical Position** before the ankles reach the surface of the water.

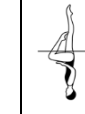
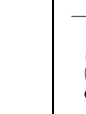

						Total
NVT=		6.0	15.0	15.0	-	36
PV =		1.67	4.17	4.17	-	



C. ANALYSIS OF FIGURES



1. ANALYSIS OF BASIC BODY POSITIONS

FINA Handbook APPENDIX II - Basic Positions



In all basic positions:

- a) arm positions are optional,
- b) toes must be pointed, ankle must be extended.
- c) the legs, trunk and neck are fully extended unless otherwise specified, and
- d) diagrams show the usual water levels.

BP 1 Back Layout Position

<u>Rule Book Description</u>	<u>Diagrams</u>	<u>Major Desired Actions</u>
1. Body extended with face, chest, thighs and feet at the surface.		1. Gives the impression that the body is stretched horizontally to its maximum. Front of the trunk will also be at the surface of the water.
2. Head (ears specifically), hips and ankles in line.		2. Judgement made by checking visual points of the horizontal alignment: ear, shoulder joint, hip joint and ankle. This imaginary line should also pass through the middle of the side of the trunk.

BP 2 Front Layout Position

<u>Rule Book Description</u>	<u>Diagrams</u>	<u>Major Desired Actions</u>
1. Body extended with head, upper back, buttocks and heels at the surface.		1. Gives the impression that the body is stretched horizontally to its maximum. Judgement made by checking visual points of the horizontal alignment: ear, shoulder joint, hip joint and ankle.
2. Unless otherwise specified, face may be in or out of the water.		2. Once established as 'in' or 'out' the head position should be maintained. When the face is out of the water, the ears will not be on the horizontal axis, and the back may be slightly lower.



BP 3 Ballet Leg Position

Rule Book Description	Diagrams	Major Desired Actions
-----------------------	----------	-----------------------

a) Surface

1. Body in **Back Layout Position**.



1. See BP 1 **Back Layout Position**.

2. One leg extended perpendicular to the surface.

2. 90° angle between extended leg and surface. Angle of ballet leg to trunk as close to 90° as possible. Ear, shoulder joint, hip joint and ankle of horizontal leg as close as possible to horizontal alignment.

b) Submerged

1. Head, trunk and horizontal leg parallel to the surface.



1. See body alignment requirements of BP 1 **Back Layout Position**.

2. One leg perpendicular to the surface with the water level between the knee and the ankle.

2. The angles between the ballet leg and the body must be 90°.

BP 4 Flamingo Position

Rule Book Description	Diagrams	Major Desired Actions
-----------------------	----------	-----------------------

a) Surface

1. One leg extended perpendicular to the surface.

1. 90° angle between the extended leg and surface.

2. The other leg drawn to the chest with the mid-calf opposite the vertical leg, foot and knee at and parallel to the surface.



2. The top of the bent leg, from knee to toes, should be "dry", with the vertical leg extended perpendicular to it midway between knee and ankle.

3. Face at the surface.

3. Chest close to the surface with the shoulders back. Ear, shoulder and hip-joint aligned with the spine straight and extended.



b) Submerged

1. Trunk, head and shin of the bent leg parallel to the surface.



1. Ear, shoulder and hip-joint aligned.

2. 90° angle between the trunk and extended leg.

3. Water level between knee and ankle of the extended leg.

BP 5 Ballet Leg Double Position

Rule Book Description

Diagrams

Major Desired Actions

a) Surface

1. Legs together and extended perpendicular to the surface.

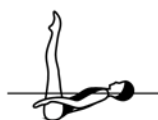

1. Full extension of the legs at a 90° angle to the surface.

2. Head in line with the trunk.

2. Chest close to the surface with the shoulders back. Ear, hip and shoulder joint aligned, with the spine straight and extended.

3. Face at the surface.

b) Submerged

1. Trunk and head parallel to the surface.



1. Ear, shoulder and hip joint aligned.

2. 90° angle between the trunk and the extended legs.

2. Legs perpendicular to the surface.

3. Water level between knees and ankles of the extended legs.





BP 6 Vertical Position

Rule Book Description	Diagrams	Major Desired Actions
1. Body extended, perpendicular to the surface, legs together, head downward.		1. Full extension of the body.
2. Head (ears specifically), hips and ankles in line.		2. Judgement made by checking visual points of the vertical alignment: ear, shoulder joint, hip joint, ankle.

BP 7 Crane Position



Rule Book Description	Diagrams	Major Desired Actions
1. Body extended in Vertical Position , with one leg extended forward at a 90° angle to the body.		1. Refer to BP 6 Vertical Position re body alignment. Forward extended leg must be parallel to the surface. Hip joints must be on a horizontal line.

BP 8 Fishtail Position



Rule Book Description	Diagrams	Major Desired Actions
1. Same as Crane Position , except that the foot of the forward leg is at the surface, regardless of the height of the hips.		1. See BP 6 Vertical Position re body alignment. The foot of the forward leg must be at the surface. Hip joints must be on a horizontal line.

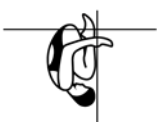

BP 9 Tuck Position



Rule Book Description	Diagrams	Major Desired Actions
1. Body as compact as possible, with the back rounded and the legs together.		1. Legs folded tightly to the front of the body.
2. Heels close to buttocks.		2. Compact tuck. Heels as close to buttocks as possible.
3. Head close to knees.		3. Chin tucked in; ears in natural alignment with the curvature of the spine.

BP 10 Front Pike Position



Rule Book Description	Diagrams	Major Desired Actions
1. Body bent at hips to form a 90° angle.		1. Exactness of 90° angle.
2. Legs extended and together.		2. Full extension of legs, with ankle aligned with hip joint.
3. Trunk extended with the back straight and head in line.		3. Back flat, with vertical alignment of ear, shoulder joint, middle of side of trunk, and hip joint. Once position is established.



BP 11 Back Pike Position

Rule Book Description	Diagrams	Major Desired Actions
1. Body bent at hips to form an acute angle of 45° or less.		1. Legs as close to chest as possible, without sacrificing the straight line alignment of the extended spine and head.
2. Legs extended and together.		2. Full extension of the legs, ankles and feet.
3. Trunk extended with the back straight and head in line.		3. Back flat, with ear, shoulder joint, middle of side of torso, and hip joint aligned. Once position is established the degree of the angle remains constant.

BP 12 Dolphin Arch Position

Rule Book Description	Diagrams	Major Desired Actions
1. Body arched so that the head, hips and feet conform to the arc being followed.		1. The body arc must be uniform from the head through the feet.
2. Legs together.		



BP 13 Surface Arch Position

Rule Book Description	Diagrams	Major Desired Actions
1. Lower back arched, with hips, shoulders and head on a vertical line.		1. Hip joints on a horizontal line; shoulder joints on a horizontal line, with both of these alignments 'square' and parallel to one another. Head (ears specifically) in line with shoulders.
2. Legs together and at the surface.		2. Hips as close to the surface as possible.

BP 14 Bent Knee Positions

Rule Book Description	Diagrams	Major Desired Actions
1. Body in Front Layout, Back Layout, Vertical, or Arched Positions .		1. See BP 2, BP 1, BP 6, BP 12 and BP 13.
2. One leg bent, with the toe of the bent leg in contact with the inside of the extended leg.		2. The relationship of the toe of the bent leg to extended leg may vary depending on the figure but should remain constant once established, and not extend behind the leg.
a) Bent Knee Front Layout Position		1. In BP 2 Front Layout Position the alignment points of the extended leg, trunk and head remain the same.
1. Body extended in Front Layout Position , with the toe of the bent leg at the knee or thigh.		1. In BP 1 Back Layout Position , Ear, shoulder joint, hip joint and ankle of extended leg as close as possible to horizontal alignment.
b) Bent Knee Back Layout Position		2. 90° angle between the thigh and surface, and as close as possible to 90° between the thigh and trunk. At maximum height, a large air pocket will be evident between the backs of the thigh and calf of the bent knee, and the surface of the water.
2. The thigh of the bent leg is perpendicular to the surface.		1. In BP 1 Back Layout Position , Ear, shoulder joint, hip joint and ankle of extended leg as close as possible to horizontal alignment.



c) Bent Knee Vertical Position

1. Body extended in **Vertical Position**, with the toe of the bent leg at the knee or thigh.



1. In BP 6 **Vertical Position** the alignment points of the extended leg, trunk and head remain the same.

d) Bent Knee Surface Arch Position

1. Body arched in **Surface Arch Position**.



1. See BP 13 **Surface Arch Position**.

2. The thigh of the bent leg is perpendicular to the surface.

2. An air pocket beneath the bent knee is also desirable.

e) Bent Knee Dolphin Arch Position

1. Body arched in **Dolphin Arch Position**, with the toe of the bent leg at the knee or thigh.



1. See BP 12 **Dolphin Arch Position**.

BP 15 Tub Position

Rule Book Description

Diagrams

Major Desired Actions

1. Legs bent and together, feet and knees at and parallel to the surface, thighs perpendicular.



1. Knee and hip joints aligned vertically. Legs "dry" from toes to knees.

2. Head in line with trunk.

2. Chest close to the surface, with the shoulders back. Ear, shoulder and hip joint aligned, with the spine extended.

3. Face at the surface.



BP 16 Split Position

Rule Book Description	Diagrams	Major Desired Actions
<ol style="list-style-type: none"> 1. Legs evenly split forward and back. 2. The legs are parallel to the surface. 3. Lower back arched, with hips, shoulders and head on a vertical line. 4. 180° angle between the extended legs (Flat split), with inside of each leg aligned on opposite sides of a horizontal line, regardless of the height of the hips. 		<ol style="list-style-type: none"> 1. Full extension of the legs at or above the surface. 4. Flat split. Hips joints on a horizontal line; shoulder joints on a horizontal line, with both of these alignments 'square' and parallel to each other.

a) Split Position

1. Legs are "dry" at the surface.



1. Full extension of the legs at the surface. Feet and thighs at the surface. Hips as close to the surface as possible.

b) Airborne Split Position

1. Legs are above the surface.

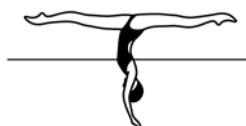

1. Full extension of the legs completely above the surface. Maximum height is desirable.

BP 17 Knight Position

Rule Book Description	Diagrams	Major Desired Actions
<ol style="list-style-type: none"> 1. Lower back arched, with hips, shoulders and head on a vertical line. 		<ol style="list-style-type: none"> 1. Arch is in the lower part of the spine only.
<ol style="list-style-type: none"> 2. One leg vertical. 		<ol style="list-style-type: none"> 2. Vertical alignment through ear, shoulder joint, hip joint and ankle.
<ol style="list-style-type: none"> 3. Other leg extended backward, with the foot at the surface, and as close to horizontal as possible. 		<ol style="list-style-type: none"> 3. Hip joints on a horizontal line; shoulder joints on a horizontal line, with both of these alignments 'square' and parallel to each other. The top of the extended leg faces upward.



BP 18 Knight Variant Position

Rule Book Description	Diagrams	Major Desired Actions
<p>1. Lower back arched, with hips, shoulders and head on a vertical line.</p>		<p>1. Arch is in the lower part of the spine only.</p>
<p>2. One leg vertical.</p>		<p>2. Vertical alignment through ear, shoulder joint, hip joint and ankle.</p>
<p>3. The other leg is behind the body with the knee bent at an angle of 90° or less.</p>		<p>3. Hip joints on a horizontal line; shoulder joints on a horizontal line, with both of these alignments 'square' and parallel to each other.</p>
<p>4. The thigh and shin are parallel to the surface of the water.</p>		<p>4. The inside of the bent leg faces upward and is at or near the surface.</p>

BP 19 Side Fishtail Position

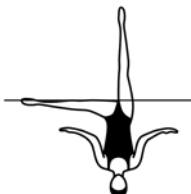

Rule Book Description	Diagrams	Major Desired Actions
<p>1. Body extended in Vertical Position, with one leg extended sideways with its foot at the surface regardless of the height of the hips.</p>		<p>1. BP 6 Vertical Position alignment must be evident from a front or back view of the extended body. The front of the extended leg faces forward.</p>





2. ANALYSIS OF BASIC MOVEMENTS

FINA Handbook APPENDIX III - Basic Movements

BM 1 To Assume a Ballet Leg

Rule Book Description	NV	Diagrams	Major Desired Actions
1. Begin in a Back Layout Position . One leg remains at the surface throughout.			1. See BP 1 Back Layout Position .
2. The foot of the other leg is drawn along the inside of the extended leg to assume a Bent Knee Back Layout Position .	10.5		2. See BP 14b Bent Knee Back Layout Position . The toe of the bending leg maintains in contact with the inside of the extended leg. Minimal drop in hips. Position held only long enough to demonstrate control and accuracy.
3. The knee is straightened, without movement of the thigh, to assume a Ballet Leg Position .	11.0		3. See BP 3a Surface Ballet Leg Position . Water line remains constant. Timing of lift same as that of draw to the bent knee position.

BM 2 To Lower a Ballet Leg

Rule Book Description	NV	Diagrams	Major Desired Actions
1. From a Ballet Leg Position , the ballet leg is bent, without movement of the thigh, to a Bent Knee Back Layout Position .	11.0		1. Timing and water line on the thigh remain the same as in <i>To Assume a Ballet Leg</i> .
2. The toe moves along the inside of the extended leg until a Back Layout Position is assumed.	10.5	 	2. Full extension and height in BP 1 Back Layout Position to be reached as the feet are joined.



BM 3 To Assume a Front Pike Position

Rule Book Description	NV	Diagrams	Major Desired Actions
<p>1. From a Front Layout Position with face in the water as the trunk moves downward to assume a Front Pike Position, the buttocks, legs and feet travel along the surface until the hips occupy the position of the head at the beginning of this action.</p>	6.0		<p>1.1 See BP 2 Front Layout Position and BP 10 Front Pike Position. Smooth, even movement downward of trunk. Trunk remains straight throughout the movement. Hips and head lock into position simultaneously.</p> <p>1.2 Unless otherwise specified, <i>To Assume a Front Pike Position</i> starts from a Front Layout Position.</p>

BM 4 A Front Pike Position to Assume a Submerged Ballet Leg Double Position

Rule Book Description	NV	Diagrams	Major Desired Actions
<p>1. From a Front Pike Position, maintaining this position, the body somersaults forward around a lateral axis so that the hips replace the head at the one quarter point to assume a Submerged Ballet Leg Double Position.</p> <p>2. The buttocks, legs and feet travel [move] downward until the hips occupy the position of the head at the beginning of this action.</p>	8.0		<p>1. See BP 10 Front Pike and BP 5b Submerged Ballet Leg Double Position. 90° angle maintained throughout rotation.</p> <p>2. Body alignment, extension and uniform speed of movement maintained.</p>

BM 5 Arch to Back Layout Finish Action

Rule Book Description	NV	Diagrams	Major Desired Actions
<p>1. From a Surface Arch Position, the hips, chest and face surface sequentially at the same point, with foot first movement to a Back Layout Position, until the head occupies the position of the hips at the beginning of this action.</p>	8.0		<p>1. See BP 13 Surface Arch Position. Sharp arch in lower back. The body straightens, rises and moves along the surface simultaneously, with a stationary BP 1 Back Layout Position achieved as the face surfaces. Full body extension maintained throughout.</p>



BM 6 Walkouts

Rule Book Description NV Diagrams Major Desired Actions

1. These movements start in a **Split Position** unless otherwise specified in the figure description. The hips remain stationary as one leg is lifted in an arc over the surface to meet the opposite leg.



1. See BP 16a **Split Position**.

a) Walkout Front

2. The front leg is lifted in a 180° arc over the surface to meet the opposite leg in a **Surface Arch Position** and with continuous movement, an *Arch to Back Layout Finish Action* is executed.



2.1 Hip height remains constant and as close to the surface as possible.
2.2 Arcing leg moves continuously at an even tempo.
2.3 Both legs maintain full extension.
2.4 Trunk maintains same position until the feet join.
2.5 An accurate BP 13 **Surface Arch Position** should be evident before the body begins to rise and straighten.
2.6 Foot first surfacing motion begins when the feet are joined.
2.7 See BP 13 **Surface Arch Position** and BM 5 *Arch to Back Layout Finish Action*.

8.0



b) Walkout Back

3. The back leg is lifted in a 180° arc over the surface to meet the opposite leg in a **Front Pike Position** and with continuous movement, the body straightens to a **Front Layout Position**.

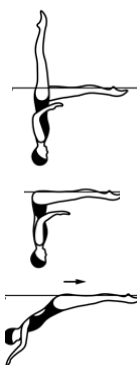

3.1 Same as 2.1-2.4 in BM6a *Walkout Front*.
3.2 An accurate BP 10 **Front Pike Position** should be evident before the body begins to straighten and rise. See BP 10 **Front Pike** and BP 2 **Front Layout Position**.

4. The head surfaces at the position occupied by the hips at the beginning of this action.

6.0



4. Body straightens, rises and moves along the surface simultaneously, with a stationary BP 2 **Front Layout Position** achieved as the head surfaces.



BM 7 *Catalina Rotation*

Rule Book Description	NV	Diagrams	Major Desired Actions
1. From a Ballet Leg Position , a rotation of the body is initiated.	24.0		1. See BP 3 Ballet Leg Positions .
2. The head, shoulders and trunk begin the rotation at the surface while descending without lateral movement to a Fishtail Position .			2.1 Rotation begins not later than when the nose goes beneath the surface of the water. 2.2 Simultaneous rotation and descent of the trunk. At the halfway point, the body is in a tilted 'Y' position, with the trunk at a 45° angle to the surface, and the front of the trunk and legs facing forward. 2.3 Height and tempo constant throughout. 2.4 See BP 7 Fishtail Position .
3. The angle between the legs remains 90° throughout the rotation. Unless otherwise specified, <i>Catalina Rotation</i> starts from a Ballet Leg Position .			3. Each leg rotates around its respective horizontal or vertical axis, simultaneous with each other and the rotation of the descending trunk.

BM 8 *Catalina Reverse Rotation*

Rule Book Description	NV	Diagrams	Major Desired Actions
1. From a Fishtail Position , the hips rotate as the trunk rises, without lateral movement, to assume a Ballet Leg Position .	24.0		1.1 See BP 7 Fishtail and BP 3 Ballet Leg Positions . 1.2 Same as 2.3 in BM 7 <i>Catalina Rotation</i> . 1.3 The body rotates and rises simultaneously, with the transition being completed as the face surfaces and the body locks into BP 3 Ballet Leg Position . At the halfway point, the body is in a tilted 'Y' position, with the trunk at a 45° angle to the surface and the front of the trunk and legs facing forward.
2. The angle between the legs remains 90° throughout the rotation.			2. Each leg rotates around its respective horizontal or vertical axis, simultaneous with each other and the rotation of the ascending trunk.



BM 9 Thrust



Rule Book Description	NV	Diagrams	Major Desired Actions
<p>1. From a Submerged Back Pike Position, with the legs perpendicular to the surface, a vertical upward movement of the legs and hips is rapidly executed as the body unrolls to assume a Vertical Position.</p> <p>2. Maximum height desirable.</p>	31.0		<p>1.1 See BP 11 Back Pike Position. The toes just below the surface are desired. Once established, the degree of the angle should not change prior to initiation of the unrolling action.</p> <p>1.2 See BP 6 Vertical Position. The body unrolls <u>under the legs</u> to assume BP 6 Vertical Position along the same perpendicular line established by the legs in the BP 11 Back Pike Position.</p> <p>1.3 Obvious increase in speed of action must be evident.</p> <p>2. Maximum height and BP 6 Vertical Position achieved simultaneously.</p>

BM 10 Vertical Descent

Rule Book Description	NV	Diagrams	Major Desired Actions
<p>1. Maintaining a Vertical Position, the body descends along its longitudinal axis until the toes are submerged.</p>	14.0		<p>1. See BP 6 Vertical Position. Unless otherwise stated, tempo of descent is uniform and at the same speed as the rest of the figure.</p>

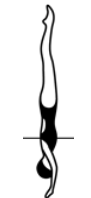
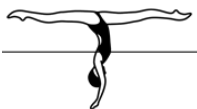
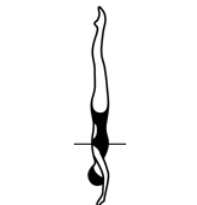

BM 11 Rocket Split

Rule Book Description	NV	Diagrams	Major Desired Actions
<p>1. A <i>Thrust</i> is executed to a Vertical Position. Maintaining maximum height the legs are split rapidly to assume an Airborne Split Position and rejoin to a Vertical Position, followed by a <i>Vertical Descent</i>.</p>	31.0	 	<p>1.1 See BM 9 <i>Thrust</i> (steps 1.1 to 2), BP 11 Back Pike Position, BP 6 Vertical Position, BP16b Airborne Split Position.</p> <p>1.2 The toes just below the surface.</p> <p>1.3 Full extension of the legs above and parallel to the surface.</p> <p>2. See BM 10 <i>Vertical Descent</i>.</p>
<p>2. The <i>Vertical Descent</i> is executed at the same tempo as the <i>Thrust</i>.</p>	43.0	 	
	15.0		



BM 12 Twists

Rule Book Description	NV	Diagrams	Major Desired Actions
1. A <i>Twist</i> is a rotation at a sustained height.			1. Water line remains constant during rotation. Stability and alignment of position evident before, during and upon completion of <i>Twist</i> . Amount of height is judged by the relationship of the hip joint to the surface of the water, with credit given to maximum height.
2. The body remains on its longitudinal axis throughout the rotation.			2. The longitudinal axis runs through the centre of the body and is perpendicular to the surface of the water. On-the-spot rotation around this axis.
3. Unless otherwise stated, when performed in a Vertical Position , a <i>Twist</i> is completed with a <i>Vertical Descent</i> .			3. See BM 10 <i>Vertical Descent</i> . Speed of descent same as that of the root figure.
4.			See Clarification on Twists.
a) Half Twist: a <i>Twist</i> of 180°.	21.0 14.0		
b) Full Twist: a <i>Twist</i> of 360°.	32.0 14.0		
c) A Twirl: a rapid <i>Twist</i> of 180°.	26.0 14.0		4. c) Definite increase in speed. Stability of body alignment and water line during and after completion of <i>Twirl</i> .

CLARIFICATION ON TWISTS: In a *Twist* figure, any deviation of $\frac{1}{4}$ + or – minus the specified amount of rotation, will result in a zero for that figure.

For example: If a *Full Twist* is required, and the swimmer completes $\frac{3}{4}$ (270°) of the rotation or LESS or $1\frac{1}{4}$ (450°) of the rotation or MORE, the score would be zero for that figure.



BM 13 Spins

Rule Book Description	NV	Diagrams	Major Desired Actions
<p>1. A <i>Spin</i> is a rotation in a Vertical Position.</p> <p>2. The body remains on its longitudinal axis throughout the rotation.</p> <p>3. Unless otherwise stated, <i>Spins</i> are executed in uniform motion.</p> <p>4. A <i>descending Spin</i> must start at the height of the vertical and be completed as the ankle(s) reach(es) the surface.</p> <p>5. Unless otherwise specified, a descending spin is finished with a vertical descent which is executed at the same tempo as the spin.</p>			<p>1. See BP 6 Vertical Position. Height and locked position attained before the <i>spin</i> begins.</p> <p>2. The longitudinal axis runs through the centre of the body and is perpendicular to the surface of the water.</p> <p>3. Uniform motion to be at the same tempo as the rest of the figure, unless otherwise stated.</p> <p>4.1 Stability and vertical alignment before, during and at completion of the designated rotation. 4.2 Simultaneous rotation and descent of the body, with even drop spaces, to complete the spin as the ankles reach the surface.</p>

6.
d) **180° Spin**: a *descending Spin* with a rotation of 180°.

18.0 (stable)
28.0 (unstable)

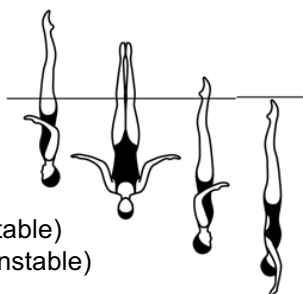

6.1 See Clarification on Spins.

e) **360° Spin**: a *descending Spin* with a rotation of 360°.

19.0 (stable)
30.0 (unstable)

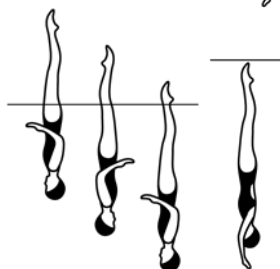

6.1 See Clarification on Spins.



f) Continuous Spin: a descending Spin with a rapid rotation of: 720° (2), 1080° (3), or 1440° (4) which is completed as the ankles reach the surface and continues through submergence.

31.0 (720°)
35.0 (1080°)
39.0 (1440°)

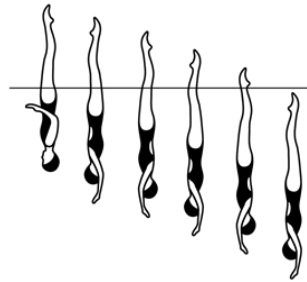

6. f) A *Continuous Spin* must achieve and maintain a fast rotation throughout. In a *Continuous Spin*, any 180° deviation (more or less) in the exact required number of rotations would receive a 0. See Rule AS 11.1.

g) Twist Spin: a *Half Twist* is executed, and without a pause, is followed by a *Continuous Spin* of 720° (2).

21.0
+
31.0
=52.0

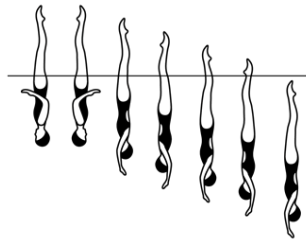

6. g) In a *Twist Spin*, the BM 12a *Half Twist* is performed at the same tempo as the root figure. BM 12a *Half Twist* and BM13 f *Continuous Spin*. See BM 10

7. An *ascending Spin* begins with the water level at the ankles unless otherwise specified.

8. A vertical upward *Spin* is executed until a water level is established between the knees and hips.

9. An *ascending Spin* is finished with a *Vertical Descent*.

10. h) **Spin Up 180°:** an *ascending Spin* with a rotation of 180°.

18.0
14.0

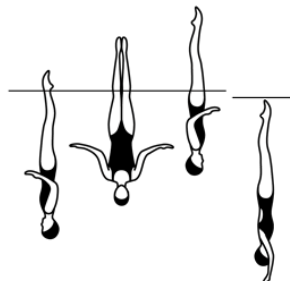

7.1 Body rises and rotates simultaneously, evenly and at the same tempo as the root figure, unless otherwise specified.

7.2 Designated rotation is completed simultaneously with achievement of maximum height.

7.3 Stability and vertical alignment maintained before, during and at completion of the designated rotation. Refer to BM 6 **Vertical Position** evident prior to *Vertical Descent*.

9. See BM10 *Vertical Descent*. Speed of descent same as that specified for root figure.

See Clarification on Spins.



i) Spin Up 360°: an ascending Spin with a rotation of 360°.

19.0
14.0

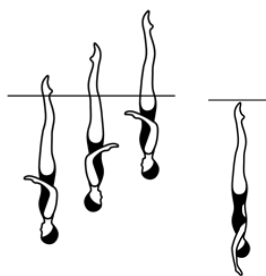

See Clarification on Spins.

j) Combined Spin: a descending Spin of at least 360°, followed without a pause by an equal ascending Spin in the same direction. The ascending Spin reaches the same height where the descending Spin started.

38.0
14.0

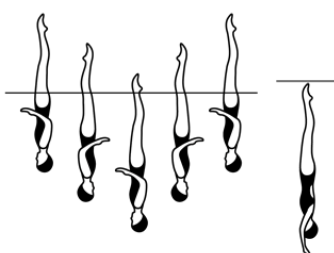

10. j) and k) - See requirements for ascending and descending spins, with uniform motion at the tempo specified in the figure description.

j) – Heights of beginning of a Descending Spin and finish of an Ascending Spin are the same. See Clarification for Combined Spins and all variations of Combined Spins.

k) Reverse Combined Spin: an ascending Spin of at least 360°, followed without a pause by an equal descending Spin in the same direction.

38.0

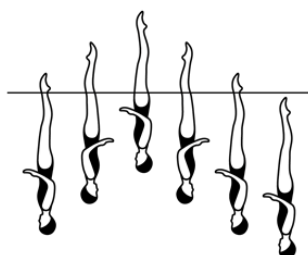

See Clarification for Combined Spins and all variations of Combined Spins.

l) Bent Knee Combined Spin: a descending Spin in a Bent Knee Vertical Position of at least 360°, followed without a pause by an equal ascending Spin in the same direction. The ascending Spin reaches the same height where the descending Spin started.

30.0
10.0

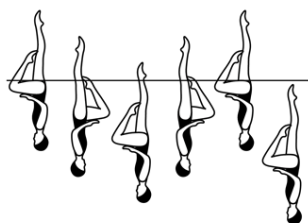

See Clarification for Combined Spins and all variations of Combined Spins.

m) Reverse Bent Knee Combined Spin: an ascending Spin in a Bent Knee Vertical Position of at least 360°, followed without a pause by an equal descending Spin in the same direction.

30.0

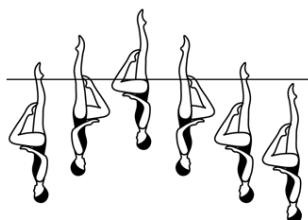

See Clarification for Combined Spins and all variations of Combined Spins.



CLARIFICATION ON SPINS:

AS 11.2 In a Continuous Spin, any 180° deviation (more or less) in the exact required number of rotations would be considered under AS 11.1 and receive a 0.

Combined spins and all variations of Combined Spins: any difference in the amount of rotation of descending and ascending spins, as well as direction of rotation as described in Appendix III BM13 will result in a zero score.

For all other spins (such as 180, 360, Spin Up 180, Spin Up 360) any deviation of ¼ + or – minus the specified amount of rotation, will result in a zero for that figure.

For example, if a 180° is required and the swimmer completes 135° (¾ of the rotation) or LESS or 225° (1 ¼ rotations or MORE, the score would be zero for that figure.

BM 14 Dolphin

Rule Book Description	NV	Diagrams	Major Desired Actions
<p>1. A <i>Dolphin</i> (and all its modifications) is started in a Back Layout Position.</p> <p>2. The body follows the circumference of a circle which has a diameter of approximately 2.5 metres, depending on the height of the swimmer.</p>			<p>1. See BP 1 Back Layout Position.</p> <p>2. The size of the circle should be in proportion to the height of the swimmer.</p>
<p>3. The head, hips and feet leave the surface sequentially to assume a Dolphin Arch Position as the body moves around the circle with the head, hips and feet following the imaginary line of the circumference.</p>		<p>8.0 + 8.0 + 8.0 + 8.0 (8.0 for each 1/4 circle)</p>	<p>3. Head, hips and feet leave the surface through the same point, with BP 12 Dolphin Arch Position achieved as the head reaches the 1/4 point of the circle. An accurate tracing of a circle will have the body pass through the 1/4, 1/2 and 3/4 points, with each quarter being the same size and shape.</p>
<p>4. Movement continues until the body straightens as it surfaces to a Back Layout Position, with the head, hips and feet breaking surface at the same point.</p>			<p>4. Body rises, straightens and moves along the surface simultaneously, with a stationary BP 1 Back Layout Position achieved as the feet surface where the head emerged.</p>



3. ANALYSIS OF FINA FIGURES

The figure categories were classified based on the initial transition of the figure.

Category I	100 Airborne
Category II	200 Circular
Category III	300 Rotation Lateral Axis
Category IV	400 Arching

106 - Ballet Leg Straight

Difficulty – 1.6

Rule Book Description NV Diagrams Major Desired Actions

1. From a **Back Layout Position** one leg is raised straight to a **Ballet Leg Position**.

1.1 See BP 1 Back Layout Position



18.5



1.2 One Leg is raised straight to BP 3 Ballet Leg Position while keeping the horizontal alignment and with minimal drop of the hips.

2. The *Ballet Leg* is lowered

11.0



2. See BM 2 To Lower A Ballet Leg.

10.5



40.0



Figure 143 – Rio

Difficulty – 3.1







Rule Book Description	NV	Diagrams	Major Desired Actions
1. A Flamingo is executed to a Surface Flamingo Position .			1. Same as Figure 130 Flamingo, steps 1 and 2.
	10.5		
	11.0		
	13.0		1.2. See BP 4a Surface Flamingo Position . Height of the ballet leg remains constant.
2. The horizontal leg is extended to a Surface Ballet Leg Double Position .	13.0		2. See BP 5a Surface Ballet Leg Double Position . Position held only long enough to demonstrate control and stability.
3. The body submerges vertically to a Back Pike Position with the toes just under the surface.	15.0		3. As the body submerges maintaining the back straight and head in line, a submerged BP11 Back Pike Position is shown. The hips are directly beneath the position they occupied in the Surface Ballet Leg Double Position .
4. The figure is completed as a Barracuda Spin 360°.	31.0		4.1 See BM 9 <i>Thrust</i> . Obvious increase in speed. The body unrolls under the legs to assume BP 6 Vertical Position along the same perpendicular line established by the legs in the Back Pike Position . Maximum height and Vertical Position achieved simultaneously, and show full extension of the Vertical Position prior to initiation of descent.
	30.0		4.2 See BM 13e Spins . Uniform rapid motion at the same rate of speed of the <i>Thrust</i> .
	123.5		

Figure 154 – London

Difficulty – 1.9

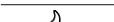

Rule Book Description	NV	Diagrams	Major Desired Actions
1. A <i>Ballet Leg</i> is assumed.			1. See BM 1 To Assume A <i>Ballet Leg</i> .
	10.5		
	11.0		
2. Followed by a partial Somersault Back Tuck as both legs are drawn into a Tuck Position , until the shins are perpendicular to the surface.	7.0		2. BP 9 inverted Tuck Position is achieved.
3. The trunk unrolls rapidly as the legs are rapidly straightened to assume a Vertical Position midway between the former vertical line through the hips and the former vertical line through the head and the shins.	18.0		3. The trunk unrolls, and BP 6 Vertical Position and maximum height achieved simultaneously. Stability and control evident prior to descent.
4. A rapid Vertical Descent is executed.	13.0		4. See BM 10 <i>Vertical Descent</i> (rapid).
	59.5		

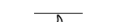

Figure 154j-2 – London Combined Spin 720

Difficulty – 2.9





Rule Book Description	NV	Diagrams	Major Desired Actions
1. A London is executed to a Vertical Position .			1. Same as Figure 154 London, steps 1, 2 and 3.
	10.5		
	11.0		
	7.0		
	18.0		
2. A rapid <i>Combined Spin</i> of 720° (descending spin 720° + ascending spin 720°) is executed.	50.0		2. See BM 13j Combined Spin (rapid).
3. A rapid <i>Vertical Descent</i> is executed.	13.0		3. See BM 10 Vertical Descent. Same tempo as <i>Combined Spin</i> . (rapid)
	109.5		



Figure 226 – Swan

Difficulty – 2.1



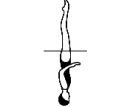
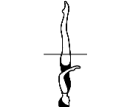
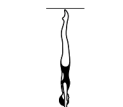

Rule Book Description	NV	Diagrams	Major Desired Actions
1. A Nova is executed to the Bent Knee Surface Arch Position .	17.5		1. See 435 Nova steps 1 and 2.
2. The bent leg straightens to assume a Knight Position .	14.0		2. With movement from the knee and no loss of height the leg is extended vertically to assume BP17 Knight Position .
3. The body rotates 180° to assume a Fishtail Position .	14.0		3. With minimal lateral axis and no loss of height, a rotation of 180 is excited to assume BP 8 Fishtail Position .
4. The vertical leg is lowered to the surface to meet the opposite leg in a Front Pike Position and with continuous movement the body straightens to a Front Layout Position .	14.5		4.1. The vertical leg moves over the surface in a 90 arc to meet the opposite leg in a Front Pike Position without movement of the trunk and with continuous motion 4.2. An accurate BP 10 Front Pike Position should be evident before the body begins to straighten and dries. See BP 2 Front Layout Position and BP 10 Front Pike Position .
5. The head surfaces at the point occupied by the hips at the beginning of this action.	6.0		5. Body straightens, rises and moves along the surface simultaneously with a stationary BP 2 Front Layout Position achieved as the head surfaces.
	66.0		

Figure 240 – Albatross

Difficulty – 2.2

Rule Book Description	NV	Diagrams	Major Desired Actions
-----------------------	----	----------	-----------------------



1. With the head leading a *Dolphin* is initiated until the hips are about to submerge.



1. See BM 14 *Dolphin*.

2. The hips, legs and feet continue to move along the surface as the body rolls onto the face as it assumes a *Front Pike Position*. 11.0



2. See BM 3 *To Assume a Front Pike Position*. The body turn, trunk descent and hip movement along the surface occur simultaneously, with the transition completed as the trunk becomes vertical and the hips replace the head at the surface.

3. The legs are lifted simultaneously to a *Bent Knee Vertical Position*. 15.0



3. Trunk remains on vertical line. Bent knee position is achieved as the vertical is reached. See BP 6 and BP14c re Bent Knee Vertical Position.

4. A *Half Twist* is executed. 15.0



4. See BM 12a *Half Twist*.

5. The bent knee is extended to *Vertical Position*. 16.5



5. See BP 6 **Vertical Position**. Water line and body alignment remain constant during extension of the bent knee.

6. A *Vertical Descent* is executed 14.0



6. See BM 10 *Vertical Descent*.

71.5



Figures 240a – 240c – Albatross Twists

Rule Book Description	NV	Diagrams	Major Desired Actions
1. An Albatross is executed until the <i>Half Twist</i> is completed.			1. See Figure 240 Albatross, steps 1 to 4.
	11.0		
	15.0		
	15.0		
2. The designated <i>twist</i> is executed as the bent knee is extended to meet the vertical leg.			2. See BM 12 <i>Twists</i> . Bent leg extends smoothly, with even joint spaces, to arrive at vertical simultaneously with completion of <i>twist</i> . Water line constant. BP 6 Vertical Position held only long enough to demonstrate stability and control prior to descent.
240a - Albatross Half Twist DD 2.2	16.5		
Total	71.5		
240b - Albatross Full Twist DD 2.3	22.0		
Total	77.0		
240c - Albatross Twirl DD 2.3	21.5		
Total	76.5		Same as Figure 240a except that a definite sharp increase in speed must be evident, with no loss of height or stability.
3. A <i>Vertical Descent</i> is executed.	14.0		3. See BM 10 <i>Vertical Descent</i> .



Figure 301 – Barracuda

Difficulty –1.9

Rule Book Description	NV	Diagrams	Major Desired Actions
1. From a Back Layout Position, the legs are raised to vertical as the body is submerged to a Back Pike Position with the toes just under the surface.	10.0		1. See BP 1 Back Layout and BP 11 Back Pike Position. In the submerged Back Pike, the hips are directly beneath the position they occupied in Back Layout. The pike is held only long enough to define the position and completion of the transition. In the Back Pike Position before the <i>Thrust</i> the feet should be below the surface of the water.
2. A <i>Thrust</i> is executed to Vertical Position.	31.0		2. See BM 9 <i>Thrust</i> . Sharp increase in speed. Body unrolls under the legs to assume BP 6 Vertical Position . Maximum height in BP 6 Vertical Position prior to initiation of descent. Vertical Position is clearly defined.
3. A <i>Vertical Descent</i> is executed at the same tempo as the <i>Thrust</i> .	15.0		3. See BM 10 Vertical Descent . Speed and accuracy.
	56.0		



308i - Barracuda Airborne Split Spin Up 360°

Difficulty – 3.3







Rule Book Description	NV	Diagrams	Major Desired Actions
1. A Barracuda Airborne Split is executed to a re-joined Vertical Position .	10.0 31.0 43.0	    	1. Same as Figure 308 Barracuda Airborne Split step 1. See BM 11 <i>Rocket Split</i> . Maximum height and BP 6 Vertical Position achieved simultaneously. See BP 11 Airborne Split Position. Full extension of the legs above and parallel to the surface. Maximum height and rapid speed throughout the split to re-join. Clear definition of BP 6 Vertical Position .
2. A <i>Vertical Descent</i> is executed at the same tempo as the <i>Thrust</i> to ankle level.	15.0		2. See BM 10 <i>Vertical Descent</i> .
3. The designated <i>Ascending Spin of 360°</i> is executed.	19.0		3. See BM 13 10i <i>Spin Up 360°</i> . The <i>Ascending Spin</i> should not be performed rapidly but should match the tempo from the Back Layout to Back Pike Position.
4. A <i>Vertical Descent</i> is executed at the same tempo as the <i>Thrust</i> .	13.0		5. See BM 10 <i>Vertical Descent</i> .
	131.0		

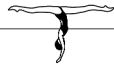

Figure 311 – Kip

Difficulty – 1.6





Rule Book Description	NV	Diagrams	Major Desired Actions
1. From a Back Layout Position, a partial Somersault Back Tuck is executed until the shins are perpendicular to the surface.	3.0		1. Same as Fig. 310, Somersault Back Tuck steps 1 & 2. Continuous motion from initiation of knee draw to achievement of inverted BP9 Tuck Position .
			
			
2. The trunk unrolls as the legs are straightened to assume a Vertical Position midway between the former vertical line through the hips and the former vertical line through the head and shins.	23.0		2. BP 6 Vertical Position and maximum height achieved simultaneously. Stability and control evident prior to initiation of descent.
3. A <i>Vertical Descent</i> is executed.	14.0		3. See BM 10 <i>Vertical Descent</i> .
	42.0		

Figure 315 – Seagull

Difficulty – 2.1



Rule Book Description	NV	Diagrams	Major Desired Actions
1. From a Back Layout Position, a partial Somersault Back Tuck is executed until the shins are perpendicular to the surface of the water.	3.0 2.0	 	1. Same as Fig. 310, steps 1 & 2. Continuous motion from initiation of knee draw to achievement of inverted BP9 Tuck Position .
2. The trunk unrolls rapidly as the legs are straightened to assume a Vertical Position midway between the former vertical line through the hips and the former vertical line through the head and the shins.	18.0		2. With a rapid motion, BP 6 Vertical Position and maximum height achieved simultaneously. Stability and control evident.
3. The legs are lowered rapidly and symmetrically to Split Position .	17.0		3. With rapid motion, BP 16a Split Position is achieved. Both legs remain equidistant from the surface at all times.
4. The leg are rapidly joined to resume Vertical Position .	16.0		4. With a rapid motion, the water line remains constant as legs are lifted to Vertical Position . Both legs remain equidistant from the surface and achieve BP 6 Vertical Position simultaneously.
5. A <i>Vertical Descent</i> is executed at the same tempo as the initial actions of the figure.	14.0		5. See BM 10 <i>Vertical Descent</i> .
	70.0		



Figure 319 – Kipswirl

Difficulty – 1.7





Rule Book Description	NV	Diagrams	Major Desired Actions
1. From a Back Layout Position , a partial Somersault Back Tuck is executed until the shins are perpendicular to the surface of the water.	3.0	 	1. Same as Fig. 310, Somersault Back Tuck steps 1 & 2. Continuous motion from initiation of knee draw to achievement of inverted BP9 Tuck Position .
2. As the trunk unrolls and the legs are straightened a 360° rotation is executed to assume a Vertical Position .	25.0		BP 6 Vertical Position and maximum height achieved simultaneously. Stability and control evident. As the trunk unrolls the legs are straightened and simultaneously rotate 360° to achieve a Vertical Position
3. A <i>Vertical Descent</i> is executed.	14.0		See BM 10 <i>Vertical Descent</i> .
	44.0		



Figure 320 – Kipswirl split closing 180°

Difficulty – 2.3

Rule Book Description	NV	Diagrams	Major Desired Actions
1.A Kipswirl is executed to the Vertical Position .			1. Same as Fig. 310, steps 1 & 2. Continuous motion from initiation of knee draw to achievement of inverted BP9 Tuck Position . BP 6 Vertical Position and maximum height achieved simultaneously. Stability and control evident. As the trunk unrolls the legs are straightened and simultaneously rotate 360° to achieve a Vertical Position
	3.0		
	2.0		
	25.0		
2. The legs are lowered symmetrically to a Split Position .	17.0		2. See BP 16a Split Position . Both legs remain equidistant from the surface at all times. Height remains constant.
3. A rapid rotation of 180° is executed, as the legs symmetrically close to a Vertical Position .	18.0		4. A rapid rotation of 180° and a closing action occur simultaneously, with completion of turn and achievement of BP 6 Vertical Position occurring as feet join. Both legs always equidistant from the surface. Longitudinal axis maintained throughout the rotation.
5. A <i>Vertical Descent</i> is executed.	14.0		3. See BP 6 Vertical Position and BM 10 Vertical Descent . Tempo of descent is uniform and at the same speed as the root figure.
	79.0		

Figure 327 – Ballerina

Difficulty – 1.8



Rule Book Description	NV	Diagrams	Major Desired Actions
1. From a Front Layout Position, a <i>Somersault Front Pike</i> is executed to a Submerged Ballet Leg Double Position.	6.0		1.1 1.1 See BP 2 Front Layout . BP 10 Front Pike Position and BM 3 <i>To Assume a Front Pike Position</i> . Smooth, even movement downwards of trunk. 1.2 See BM4 <i>A Front Pike Position to Assume a Submerged Ballet Leg Double Position</i> .
	8.0		
2. One knee is bent to assume a Submerged Flamingo Position.	3.0		2. See BP 4b Submerged Flamingo Position . Water level should remain constant on the vertical leg.
3. Maintaining this position, the body rises to a Surface Flamingo Position.	10.0		3. See BP 4a Flamingo Position . Face and shin of bent leg surface simultaneously. Body rises along vertical line established by legs in original Submerged Ballet Leg Double Position.
4. The ballet leg is lowered in a 90° arc to the surface as the other leg moves to assume a Bent Knee Position.	15.0		4. See BP14b Bent Knee Back Layout Position and BP 1 Back Layout Position. Thigh of bent leg achieves vertical line and maximum height as foot of extended leg reaches the surface.
5. The toe moves along the inside of the extended leg until a Back Layout Position is assumed.	10.5		5. Full extension and height in BP 1 Back Layout Position to be achieved as the feet are joined.
	52.5		

Figure 330 – Aurora

Difficulty – 2.3

Rule Book Description	NV	Diagrams	Major Desired Actions
-----------------------	----	----------	-----------------------



1. From a Front Layout Position, a Somersault Front Pike is executed to a Submerged Ballet Leg Double Position.

6.0



8.0



1.2 See BP 2 **Front Layout**. BP 10 **Front Pike Position** and BM 3 *To Assume a Front Pike Position*. Smooth, even movement downwards of trunk.

1.2 See BM4 *A Front Pike Position to Assume a Submerged Ballet Leg Double Position*.

2. One leg rises vertically as the other moves along the surface to a Knight Position.

16.0



2. The trunk unrolls beneath the vertical leg. Movement of trunk and legs to BP 17 Knight Position is simultaneous with rise, with maximum height and body alignment achieved simultaneously.

3. The body rotates 180° to assume a Fishtail Position.

14.0



3. See BP 8 **Fishtail Position**. Height constant. Horizontal and vertical legs maintain alignment during rotation.

4. The horizontal leg is lifted to a **Vertical Position**.

20.5



4. See BP 6 **Vertical Position**. Height constant as legs join, with the trunk and vertical leg maintaining vertical alignment. Stability in BP 6 **Vertical Position** evident prior to descent.

5. A *Vertical Descent* is executed.

14.0



5. See BM 10 *Vertical Descent*.

78.5



Figure 330c – Aurora twirl

Difficulty – 2.8

Rule Book Description	NV	Diagrams	Major Desired Actions
1. An Aurora is executed to Vertical Position.			1. Refer to Figure 330 Aurora Steps 1-4.
	6.0		
	8.0		
	16.0		
	14.0		
	20.5		
2. A <i>Twirl</i> is executed.	26.0		5. Definite increase in speed. Stability of body alignment and water line during and after completion of BM 12c <i>Twirl</i> .
3. A <i>Vertical Descent</i> is executed.	14.0		6. See BP 6 Vertical Position . Tempo of descent is uniform and at the same speed as the root figure.
	104.5		



Figure 343 – Butterfly

Difficulty – 2.5

Rule Book Description	NV	Diagrams	Major Desired Actions
1. From a Front Layout Position , a <i>Front Pike Position</i> is assumed.	6.0	 	1.3 1. See BP 2 Front Layout . BP 10 Front Pike Position and BM 3 <i>To Assume a Front Pike Position</i> . Smooth, even movement downwards of trunk.
2. One leg is lifted to a Fishtail Position .	14.5		2. See BP 8 Fishtail Position . Height and water alignment of trunk maintained. Stability and control evident.
3. The horizontal leg is rapidly lifted through an arc of 180° as the vertical leg is lowered to assume a Split Position , without hesitating a hip rotation of 180° is executed as the front leg is raised to assume a Fishtail Position .	20.0		3. See BP 16 Split Position and BP 8 Fishtail Position . Sharp increase in speed. Both legs start BP 8 Fishtail Position and achieve BP 16 Split Position simultaneously.
	16.5		Foot of stationary leg remains at the surface during 180° rotation. Trunk maintains its vertical alignment with hips and shoulders 'square'.
4. The horizontal leg is lifted to a Vertical Position at the same tempo as the initial actions of the figure.	20.5		4. See BP 6 Vertical Position . Height constant as legs join with the trunk and vertical leg maintaining their vertical alignment. Stability in BP 6 Vertical Position evident prior to descent.
5. A <i>Vertical Descent</i> is executed	14.0		4. See BM 10 <i>Vertical Descent</i>
	91.5		

Figure 350 – Dalecarlia

Difficulty –2.6









Rule Book Description	NV	Diagrams	Major Desired Actions
1. From a Front Layout Position a <i>Front Pike Position</i> is assumed.	6.0	 	1.4 1. See BP 2 Front Layout . BP 10 Front Pike Position and BM 3 <i>To Assume a Front Pike Position</i> . Smooth, even movement downwards of trunk.
2. One leg is lifted to a Fishtail Position .	14.5		2. See BP 8 Fishtail Position . Height and vertical alignment of trunk maintained. Stability and control evident from steps 2-4. Height constant with hips as pivot point during steps 2 to 4.
3. Maintaining the angle between the legs, the horizontal leg moves to vertical as the vertical leg simultaneously continues its arc to the surface to assume a Knight Position .	31.0		3. See BP 17 Knight Position . Height and vertical alignment of trunk maintained..
4. Without moving the legs, the trunk straightens as it rises to a Surface Ballet Leg Position .	22.0		4. See BP 3a Ballet Leg Position Hip level and leg alignment remain constant.
5. <i>The Ballet Leg is lowered.</i>	11.0		5. See BM 2 <i>To Lower A Ballet Leg</i> .
	10.5		
	95.0		



Figure 351 – Jupiter

Difficulty – 2.8

Rule Book Description	NV	Diagrams	Major Desired Actions
1. A Dalecarlia is executed to a Knight Position .			1. See Figure 350 Dalecarlia for steps 1-3.
	6.0		
	14.5		
	31.0		
2. Maintaining the vertical alignment of the body, the horizontal leg is moved in a 180° arc at the surface of the water to a Fishtail Position.	18.0		2. See BP 8 Fishtail Position . Vertical leg remains stationary with a constant water line. Foot of the horizontal leg to be at the surface, not above.
3. The horizontal leg is lifted to the Vertical Position.	20.5		3. Height maintained. Trunk and vertical leg maintain alignment during lift. Stability and control evident in BP 6 Vertical Position prior to descent.
6. A <i>Vertical Descent</i> is executed.	14.0		6. See BM 10 <i>Vertical Descent</i> .
	104.0		



Figure 355 – Porpoise

Difficulty – 1.8





Rule Book Description	NV	Diagrams	Major Desired Actions
1. From a Front Layout Position, a <i>Front Pike Position</i> is assumed.	6.0	 	1.5 See BP 2 Front Layout . BP 10 Front Pike Position and BM 3 <i>To Assume a Front Pike Position</i> . Smooth, even movement downwards of trunk.
2. The legs are lifted to Vertical Position.	33.0		2. Trunk remains on vertical line as legs are lifted. Maximum height and BP 6 Vertical Position achieved simultaneously. Vertical held only long enough to demonstrate stability and control.
3. A <i>Vertical Descent</i> is executed.	14.0		3. See BM 10 <i>Vertical Descent</i> .
	53.0		



Figure 355f – Porpoise Continuous Spin 720°

Difficulty – 2.1

Rule Book Description	NV	Diagrams	Major Desired Actions
1. A Porpoise is executed to Vertical Position.			1. See Figure 355 Porpoise for steps 1-2.
	6.0		
	33.0		
2. A <i>Continuous Spin of 720°</i> is executed.	31.0		2. See BM 13f <i>Continuous Spin</i> . A rapid rotation of 720° (2) which is completed as the ankles reach the surface and continues through submergence. It must achieve and maintain a rapid rotation throughout. Spacing and timing is even without acceleration.
	70.0		



Figure 355g – Porpoise Twist Spin

Difficulty – 2.5





Rule Book Description	NV	Diagrams	Major Desired Actions
1. A Porpoise is executed to Vertical Position.			1. See Figure 355 Porpoise for steps 1-2.
	6.0		
	33.0		
2. A <i>Twist Spin</i> is executed.	48.0		2. See BM 13g <i>Twist Spin</i> . A Half Twist is executed and without a pause, is followed by a <i>Continuous Spin of 720° (2)</i> which is completed as the ankles reach the surface and continues through submergence. The twist is performed at the same tempo as the root figure. Tempo of the Continuous Spin is rapid.
			
	87.0		



Figure 363 – Water Drop







Difficulty – 1.5

Rule Book Description	NV	Diagrams	Major Desired Actions
1. From a Front Layout Position, a <i>Front Pike Position</i> is assumed.	6.0		1.6 See BP 2 Front Layout . BP 10 Front Pike Position and BM 3 <i>To Assume a Front Pike Position</i> . Smooth, even movement downwards of trunk.
2. The legs are lifted simultaneously to a Bent Knee Vertical Position.	15.0		2. Trunk remains on vertical line. Bent knee position is achieved as the vertical is reached. See BP 6 and BP14c Bent Knee Vertical Position.
3. A <i>180° Spin</i> is executed as the bent knee is extended to a Vertical Position before the ankles reach the surface of the water.	15.0		3. See BM 13 <i>Spins</i> . Body alignment remains constant during extension of the bent knee. Bent leg arrives at vertical simultaneously with completion of the <i>Spin</i> . The bent leg is extended upward at the same rate of space and time as that of the drop spaces of the vertical leg, See BM 10 <i>Vertical Descent</i> . Simultaneous descent and extension of bent knee without a pause as feet join.
36.0			



Figure 364 – Whirlwind

Difficulty – 2.7

Rule Book Description	NV	Diagrams	Major Desired Actions
1. From a Front Layout Position, a <i>Front Pike Position</i> is assumed.	6.0	 	1.7 See BP 2 Front Layout . BP 10 Front Pike Position and BM 3 <i>To Assume a Front Pike Position</i> . Smooth, even movement downwards of trunk.
2. One leg is lifted to a Fishtail Position .	14.5		2. See BP 7 Fishtail . Height and vertical alignment of the trunk maintained. Stability and control evident.
3. Maintaining a Fishtail Position with the horizontal leg leading toward the vertical leg, two rapid rotations (720°) are executed.	50.0		<p>3.1 The water level remains constant during the rotation.</p> <p>3.2 A 90° angle between the two legs is maintained throughout the two rotations (720°)</p> <p>3.3 The longitudinal axis runs through the center of the body and is perpendicular to the surface of the water.</p> <p>3.4 The speed of the rotations is rapid.</p>
4. Continuing in the same direction, the horizontal leg is lifted to a Vertical Position as a Continuous Spin 720° is executed.	29.5	 	<p>4.1 A rapid rotation of 720° and a closing action occur simultaneously, with completion of turn and achievement of BP 6 Vertical Position occurring as the ankles reach the surface and continue through submergence. Both legs always equidistant from the surface. Longitudinal axis maintained throughout the rotation.</p> <p>4.2 Spacing and timing are even all through without acceleration.</p>

100.0



Figure 401 – Swordfish

Difficulty – 2.0









Rule Book Description	NV	Diagrams	Major Desired Actions
1. From a Front Layout Position, a Bent Knee Position is assumed.	4.0		1. See BP2 Front Layout and BP 14 Bent Knee Front Layout Position . There can be no change of head position once the knee starts to bend to assume the Bent Knee Front Layout Position .
2. The back arches more as the extended leg is lifted in a 180° arc over the surface to assume a Bent Knee Surface Arch Position .	35.0		2. See BP13 and BP14. Lifting of the extended leg and arching of the back occur simultaneously. Foot comes off the surface as the head goes under. Hips maintain height and are pivot point about which body rotates
3. The bent knee is straightened to assume a Surface Arch Position and with continuous motion,	14.5		3. See BP 13 Surface Arch Position . Trunk maintains same position until the feet join. Surface Arch Position should be shown, but not held. Hip joints on a horizontal line, full extension of legs with thighs and feet at the surface.
4. an <i>Arch to Back Layout Finish Action</i> is executed.	8.0		4. See BM 5 <i>Arch to Back Layout Finish Action</i> . Feet join, then surfacing action begins. At the end the face, body, legs and feet are at the surface
	61.5		

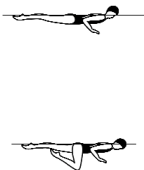

Figure 403 – Swordtail

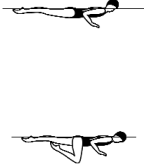
Difficulty – 2.3

Rule Book Description	NV	Diagrams	Major Desired Actions
1. From a Front Layout Position, a Bent Knee Position is assumed.	4.0		1. See BP2 Front Layout and BP 14 Bent Knee Front Layout Position . There can be no change of head position once the knee starts to bend to assume the Bent Knee Front Layout Position .
2. The back arches more as the extended leg is lifted in a 180° arc over the surface of the water.	29.0		2. See BP 13 and BP14. Lifting of the extended leg and arching of the back occur simultaneously. Foot comes off the surface as the head goes under. Hips maintain height and are pivot point about which the body rotates.
3. As the extended leg passes vertical, the bent leg straightens with the foot following a vertical line to assume a Knight Position.	20.0		3. Continuous motion. Simultaneous extension of bent leg and lowering of extended leg to BP 17 accurate Knight Position. Hip level constant with hips as pivot point during steps 1 to 3.
4. The vertical leg is lowered to a Surface Arch Position.	18.5		4. See BP 13 Surface Arch Position. Trunk maintains same position until the feet join. Surface Arch Position should be shown, but not held. Hip joints on a horizontal line, full extension of legs with thighs and feet at the surface.
5. An Arch to Back Layout Finish Action is executed.	8.0		5. See BM 5 <i>Arch to Back Layout Finish Action</i> . Feet join, then surfacing action begins. At the end the face, body, legs and feet are at the surface.

79.5



Figure 420 – Walkover Back

Difficulty –1.9





Rule Book Description	NV	Diagrams	Major Desired Actions
1. With the head leading, a <i>Dolphin</i> is initiated.			1. BM 14 <i>Dolphin</i> continues until the hips are about to submerge.
2. The hips, legs and feet continue to move along the surface as the back is arched more to assume a Surface Arch Position.	12.0		2. Continuous movement from initiation of step 1 until achievement of BP 13 Surface Arch Position.
3. One leg is lifted in a 180° arc over the surface to a Split Position.	22.0		3. The back leg remains fully extended. Hips remain stationary, aligned horizontally, and at the surface. Continuous uniform motion of leg arcing to BP 16 Split Position.
4. A <i>Walkover Back</i> is executed.	19.0		4. See BM 6b <i>Walkout Back</i> .
	6.0		
	59.0		



Figure 423 – Ariana

Difficulty – 2.2

Rule Book Description	NV	Diagrams	Major Desired Actions
1. A Walkover Back is executed to a Split Position.			1. Same as Figure 420 Walkover Back, steps 1 to 3.
	12.0		
	22.0		
2. Maintaining the relative position of the legs to the surface, hips rotate 180°.	10.0		2. The <u>trunk</u> turns 180° around its longitudinal axis, while the <u>legs</u> rotate horizontally at the surface, with the height and extension of BP16 Split Position equal throughout.
3. A <i>Walkout Front</i> is executed.	23.0		3. See BM 5 <i>Arch up to Back Layout Finish</i> . Feet join, then surfacing action begins. At the end the face, body, legs and feet are at the surface
	8.0		
	75.0		



Figure 435 – Nova

Difficulty – 2.2





Rule Book Description	NV	Diagrams	Major Desired Actions
1. With the head leading a <i>Dolphin</i> is initiated until the hips are about to submerge.			1. See BM 14 <i>Dolphin</i> .
2. The hips, legs and feet continue to move along the surface as the back is arched more as one knee is bent to assume a Bent Knee Surface Arch Position .	17.5		2. Continuous uniform movement BP 1 Back Layout Position to BP14d Bent Knee Surface Arch Position . Hip height constant. Both hip joints on a horizontal line.
3. The legs are lifted to a Bent Knee Vertical Position .	21.0		3. See BP 14c Bent Knee Vertical Position . Body height and position of toe of bent leg on extended leg remain constant. Trunk alignment maintained beneath hips and shoulders. Hips and shoulders aligned horizontally and 'square'.
4. A <i>Full Twist</i> is executed as the bent leg is extended to meet the vertical leg.	22.0		4. See BM 12. Continuous, smooth straightening of bent leg completed simultaneously with completion of the <i>Full Twist</i> . Maintenance of height, stability and vertical alignment throughout.
5.A <i>Vertical Descent</i> is executed.	14.0		See BM 10 <i>Vertical Descent</i> .
	74.5		



Figure 437 – Oceanea

Difficulty – 2.1

Rule Book Description	NV	Diagrams	Major Desired Actions
1. A Nova is executed to a Surface Arch Bent Knee Position.	17.5		1. See Figure 435 Nova steps 1 & 2.
2. The horizontal leg is lifted to the vertical as the bent knee is extended to assume a Vertical Position.	21.0		2. See BP14d Bent Knee Vertical Surface Arch Position and BP 6 Vertical Position. Horizontal alignment of hips and shoulders 'square' and maintained during lift. Bent leg arrives at vertical simultaneously with completion of feet join. The bent leg is extended upward at the same rate of space and time as that of the lift spaces of the vertical leg.
3. A <i>Continuous Spin</i> of 720° (2 rotations) is executed.	31.0		3. See BM 13f <i>Continuous Spin</i> . Completed as the ankles reach the surface and continues through submergence. Speed is rapid.
	69.5		



Figure 440 – Ipanema

Difficulty – 3.0

Rule Book Description	NV	Diagrams	Major Desired Actions
1. A Nova is executed to a Bent Knee Surface Arch Position.	17.5		1. See Figure 435 Nova steps 1 & 2.
2. The horizontal leg is lifted as the bent knee is straightened to assume a Vertical Position .	21.0		<p>2.1 Without loss of body height, the legs are lifted and the bent leg extends simultaneously to BP 6 Vertical Position.</p> <p>2.2 Trunk alignment maintained beneath hips and shoulders. Hips and shoulders aligned horizontally and squared.</p>
3. The legs are lowered to a Front Pike Position .	33.0		3. Without loss of height and horizontal alignment of head, hips and shoulders, the legs are lowered to BP 10 Front Pike Position .
4. A rapid 180° rotation is executed as the legs lift to a Vertical Position .	33.0		4. Without loss of height, the body rotates 180° as it straightens to BP 6 Vertical Position . (As it reaches 90 rotation, the legs reach a 45 angle with the water).
5. A <i>Vertical Descent</i> is executed at the tempo of the rest of the figure.	14.0		5. See BM 10 <i>Vertical Descent</i> . Tempo is the same as root figure, not rapid.
	118.5		



SECTION III

ROUTINES



A. GUIDELINES FOR PRESENTATION OF ROUTINES

Several aspects of presenting a routine are not judging factors, but may subjectively affect the performance and how it is perceived by spectators, judges and media.

Although judges are trained to evaluate only those aspects of a performance which are covered in the rules, at some level their score may be affected by extraneous factors.

Following are rules and guidelines which coaches and athletes should be aware of when presenting routines.

1. GUIDELINES FOR ROUTINE WALK-ONS

- AS 14.1 Time limits for Technical Routines, Free Routines, Free Combination and Highlight Routine including ten seconds for deck movements. (see all AS14.1 rules for specific time limits)
- ASAG 6 Time limits for different age groups, including 10 seconds for deck movement.
- AS 14.1.8 In all routine events, the walk-on of the competitors from the designated starting point to the achievement of a stationary position(s) may not exceed 30 seconds. Timing shall commence when the first competitor passes the starting point and ends when the last competitor becomes stationary.
- AS 18.3.3 A one point penalty shall be deducted from the routine score if the time limit of 30 seconds for the deck walk-on on is exceeded.
- AS 18.3.7 A two-point penalty shall be deducted from the routine score if during the deck movements in routines, competitors execute stacks, towers or human pyramids.

2. GUIDELINES AND RULES FOR SWIMWEAR AND APPEARANCE

Public image is important. Appropriate swimwear enhances this image. Swimwear should reflect the athletic nature of the sport and not be a costume more suited to a stage production.

- AS 13.9 Theatrical make-up shall not be worn. Make-up that provides a natural, clean and healthy glow is acceptable.
- AS 13.10 The use of accessory equipment, goggles, or additional clothing is not permitted unless required for medical reasons.
- AS 13.11 Nose clips or plugs may be worn.
- AS 13.12 Jewelry is not allowed. Competitors must remove the jewelry prior to the start of the routine.



- BL 8.8 Swimwear for men in Artistic Swimming shall not extend above the navel nor below the upper thigh. Men shall not wear makeup. Hair gel is permitted. Mustaches are allowed.

Guidelines:

- Headpieces should stay in place and not come loose in the water
- Hair should stay firmly in place
- Makeup should be age appropriate
- The face should not be a mask, such as a clown face or a white “mask” with a tear on the cheek

3. MUSIC CONCERNS

While the choice of music is not a judging factor, good music will always enhance the performance in the minds of all viewers. Poor music – in choice or in the quality of sound reproduction – will ultimately detract.

High quality music production at an Artistic Swimming competition is essential to success and greatly influences how a routine is received by spectators, judges and media.

Music should encompass a harmonious whole, with suitable editing and a good blend of selections that make sense together. Bits and pieces of unrelated music can be distracting and annoying. Poor cuts are equally problematic. Levels of volume should be considered when the music is being edited.

Selection and interpretation of the music should not reflect on concepts which are offensive to any culture. Horror scenes, prison scenes, violence or death scenes are not suitable for an Olympic sport.

See AS.15 for all matters concerning Music Accompaniments.



B. FREE ROUTINES

1. FREE ROUTINE RULES

AS 4.3 Free Routine: Preliminaries / Finals

Each Solo, Duet, Mixed Duet and Team must perform the Free Routine, which may consist of any listed figures, strokes and / or parts thereof to music.

Free Routines have no restrictions as to the choice of music, content or choreography.

Free Team Routines have a maximum of six acrobatic movements. This does not include partner (2 swimmers) lifts. The acrobatic movement ends with complete submersion of all participants including the one(s) being pushed.

For multiple acrobatic movements:

When submersion occurs between two acrobatic movements it will be considered as two lifts.

When two acrobatic movements happen simultaneously it will be considered as one lift.

AS 18.3.8 In Team Free Routines, if the number of acrobatic movements exceeds the required elements, a two point penalty shall be deducted from the routine score. Regardless of the number of additional acrobatic movements, the maximum penalty would be two points.

2. FREE ROUTINE SCORING RULES

AS 17 JUDGEMENT OF ROUTINES

AS 17.1 In Routines the competitor can obtain points from 0 – 10 using 1/10th points.

Perfect	10	Satisfactory	5.9 – 5.0
Near perfect	9.9 – 9.5	Deficient	4.9 – 4.0
Excellent	9.4 – 9.0	Weak	3.9 – 3.0
Very Good	8.9 – 8.0	Very weak	2.9 – 2.0
Good	7.9 – 7.0	Hardly recognisable	1.9 – 0.1
Competent	6.9 – 6.0	Completely failed	0

AS 17.2 In Free Routines, Free Combination Routines and Highlight Routines each judge shall award one score, from 0 – 10 points each (see AS 17.1). Execution panel judges shall award one score for Execution and Synchronisation. Artistic Impression panel judges shall award one score for Choreography, Music Interpretation, and Manner of Presentation. The difficulty panel judges shall award a score for Difficulty.



All the following percent arrays are subject to the decision of the TASC.

AS 17.2.1 First panel – EXECUTION Score - 30%

Consider:

	Free Solo	Free Duet Mixed Duet	Free Team Free Combination Highlight Routine
EXECUTION – the level of excellence in performing highly specialised skills. Execution of all movements.	90%	50%	50%
SYNCHRONISATION - the precision of movements in unison, one with the other, and the accompaniment above, at and below the surface. Synchronisation of timing of one with another and with music.	10%	50%	50%

AS 17.2.2 Second panel – ARTISTIC IMPRESSION Score - 40%

Consider:

	Free Solo	Free Duet Mixed Duet	Free Team Free Combination Highlight Routine
CHOREOGRAPHY - the creative skill of composing a routine that combines artistic and technical elements. The design and weaving together of variety and creativity of all movements.	100%	100%	100%
MUSIC INTERPRETATION - expressing the mood of the music, use of the music's structure.			
MANNER OF PRESENTATION - the manner in which the swimmer(s) present(s) the routine to the viewers. The total command of the performance of the routine.			

AS 17.2.3 Third panel – DIFFICULTY Score - 30%

Consider:

	Free Solo	Free Duet Mixed Duet	Free Team Free Combination Highlight Routine
DIFFICULTY – the quality of being hard to achieve. Difficulty of all movements and of synchronisation.	100%	100%	100%



3. JUDGING FREE ROUTINES

3.1 GENERAL OVERVIEW

Artistic Swimming routine judging may be more difficult than any other sports judging task. Even with the judging split between three panels, each judge has more elements to evaluate simultaneously and continuously throughout the routine than judges of any other sport. Reliable analysis can be made only by a judge who is well prepared, who has become thoroughly familiar with each of the categories and elements to be analysed, and who has developed a valid scale of excellence to apply to each competitor. The judge must apply those scales while utilising the criteria as objectively as possible. With training and conscientious application of standards, all judges should be able to produce reliable and valid scores.

The status we seek:

Knowledgeable and objective judging by application of the designated criteria, free from prejudice and preconceptions.

3.2 WHAT JUDGES ASSESS

a) Judge objectively by using the criteria

The judges on each panel will assign a score for the Execution, Artistic Impression or Difficulty scores, according to the criteria and as objectively as possible. Each panel should be independent and the panels should not influence each other.

b) Judge what the swimmer(s) performed in front of you

Do not judge based on what you expected to see or what you saw in the past. Do not be influenced by previous results.

c) Judge throughout a routine

The routine is from the start to the end of the accompaniment (AS 14.2). Judging begins upon a signal from the referee or appointed official (AS 14.3).

d) Judge all swimmers and all actions in the routine

In Team, Free Combination and Highlight Routines, judge all swimmers who perform or do not perform, and all actions above, at and below the surface.



4. JUDGING EXECUTION

Execution is the level of excellence demonstrated through the swimmer's mastery of highly specialised skills. Execution is how well the competitors do whatever they perform. The Execution score covers two areas: Execution (Solo –90%, Duet and Team –50%) and Synchronisation (Solo –10%, Duet and Team –50%).

4.1 EXECUTION

4.1.1 Hybrid figures, strokes, propulsion techniques and transitions

a) Height

As high as possible is the ideal for most actions. See the Guiding Height Scale for hybrid figures, eggbeater kicking and boosts.

b) Well-defined and accuracy

Strokes, propulsion techniques—Arm positions should be well-defined, extended when appropriate, with clear angles of arms and hands. Head and shoulder positions should be well-defined for strokes and in alignment for sculling. Stroke entry into the water should be efficiently completed.

Hybrid figures—Judges need to look for the accuracy of all lines and positions, considering them in the same manner as for figure competition. Look for the horizontal and vertical lines, accurate pike and compact tuck positions, wide split position (full 180 degrees), correct ballet leg, bent knee, crane and fishtail positions, etc. In all hybrid actions, there should be precise body and limb positions with angles well-defined.

Lack of sharpness and accuracy in Duets and Teams must be considered an execution error and not poor timing.

c) Extension, full body extension throughout action

In figures, the knees, ankles, feet and toes should always be fully extended with no relaxation of extension during any part of the execution, unless clearly intended otherwise in the choreography. Horizontal and vertical alignments need to be exact, with head (ears), hips and ankles in line. In strokes and propulsion techniques, the fingers, arms, neck and the shoulders should be fully extended.

d) Efficiency

Maximum efficiency (result) with minimum effort; judges should look for efficient, effective strokes and kicks.



e) Smoothness and apparent effortless

All actions should be smooth and seemingly effortless throughout, without bouncing, jerkiness or splashing unless clearly intended otherwise in the choreography.

Ease of motion and seemingly effortless action must be shown in all positions, movements and transitions, from beginning to end.

Fluidity must be seen through all transitions. The most effective transitions are hardly perceived by the viewer and are accomplished so smoothly and naturally that they are finished before one is aware what has happened.

Transitions are judged by the same principles as those guiding the judgement of stroking, propulsion and figures. Whether from stroke to figure, figure to stroke, within a figure or the changing patterns in a duet or team, all transitions should flow from start to finish—smoothly, logically and effortlessly. They should be efficient and purposeful.

f) Stability and control

There should not be any excessive, extraneous movements, unplanned travel or loss of control, extension or height during a transition. The tempo should be consistent (except when altered for choreographic effect) with clear, fluid motion from start to finish. Action should flow from stroke to figure and figure to stroke, with no loss of height or efficiency. Body lines must be maintained with seemingly effortless motion within transitions. Descents must be completed through the surface until the toes are underneath the water, with clearly planned underwater movements to return to the surface.

g) Strength, power, and energy level

Stroking, kicking and sculling must be strong and powerful to provide strong support for weight held above the surface of the water and for efficient, effective propulsion throughout. There should be evidence of a high energy level with no loss of power, speed or height throughout the routine.

Athletes must demonstrate strength and power necessary to provide support for any weight held above the water, for lifting and thrusting actions, and for stability in all figure positions and movements. The energy level must remain high to control and maintain the actions with consistent tempo throughout.

4.1.2 Risk elements: acrobatic movements (platforms, stacks, lifts, throws) and floats

Execution of these actions is judged by the same principles as those guiding other elements. The judge must be cautioned to evaluate the whole action, from set-up to completion and not just the final product. Judges evaluate the position achieved, or the stable platform with the 'statue' in control on top. Stacks, lifts and throws must clearly demonstrate height, timing and control with an efficiency of movement. Floating actions must show accurate positioning and control.

a) Clearly defined

These special highlight movements must be clear and easily recognisable, shown long enough to be understood and displaying a definite completion or finish of the action.



b) Stability in achieving and maintaining position(s)

There should not be any 'falling off' or loss of balance, or failure to achieve a lift or throw, or to connect in a float or any such movements attempted. All are part of the execution of the action and must be considered in the Execution score.

c) Height where appropriate

Effective throws and lifts may achieve great heights, with athletes rising cleanly to appropriate levels, often well above the surface.

d) Minimal set-up and recovery time

Minimal time should be given to the set-up and the completion of the action. Both should be achieved without an underwater scramble or struggle.

4.1.3 Patterns and Pattern changes

Team routines consist of a series of formations and the movements between those formations. Patterns will be constantly changing and should change so effectively that the changes are hardly apparent.

In this element, the judge does not consider the types, number or difficulty of the patterns—only the excellence of their performance.

a) Clear, precise formations, easily identified

The pattern shape must be easily identifiable, with accurate positioning of the athletes in relation to each other and to the pool space.

The accuracy of the patterns is extremely important in the team event. When the patterns are executed with precision, the overall effect will be sharpness and clarity of purpose. The spatial relationships between the swimmers will be exact. When the position is asymmetrical, it will be clearly demonstrated.

A lack of precision in the execution of patterns will create a 'fuzzy' impression not only of the pattern but the routine as a whole.

The shape of the pattern should be immediately recognisable, such as:

- square, rectangle, triangle, circle, diamond, railroad tracks
- straight, diagonal or curved lines
- a letter of the alphabet such as 'X', 'O', 'H', 'T', 'L', 'V', 'Y', 'I', or 'Z'
- symmetric or asymmetric
- spacing may be spread, close together or joined

b) Maintenance of the pattern shape

Athletes must maintain the pattern formation while moving and performing figures, hybrid actions, strokes and propulsion techniques.



c) Well-defined, efficient pattern changes

All pattern changes must be well-defined, logical and efficient—both surface changes and those made underwater. There should not be long underwater swims nor should excessive time be taken to reach new positions.

4.1.4 Execution of the total routine

Judges must remember that the Execution score is for the total routine. In some cases, fatigue may degrade execution as the routine progresses. The judge needs to consider whether the athlete maintained the same excellence from beginning to end and ensure that the score reflects the overall routine, rather than letting a problem at the end (or in the beginning or middle) become a major determinant of the total Execution award. Consider the failed or poorly executed portion in relation to the approximate length of time it consumed out of the total routine.

4.2 SYNCHRONISATION

Synchronisation is the precision of movements in unison, one with the other and also with the musical accompaniment, while above, at and below the surface. To synchronise is 'to make things happen at the same time' or 'to be in unison.' Because it is easy to detect a swimmer's failure to act perfectly in unison with others, synchronisation may be one of the easier categories to judge. The judge must take precautions, though, not to allow that simplicity to lead to its domination of the Execution score. In Artistic Swimming, not only should the swimmers' movements be in unison with each other, but their actions must also be in time with the accompaniment.

For a Solo, the latter is the only form of synchronisation, so it can only be more loosely defined. Actions may be coordinated with the music's rhythm, melody or accent points or they may simply represent its mood. This factor counts for only 10% of the solo Execution award. The judge may have to rely on evaluating whether there were major deviations from the tempo or feeling of the music, or obvious failure to match actions with a musical accent or highlight.

The value of synchronisation rises to 50% for Duets and Teams due to the need for, and the difficulty of, precisely coordinating the movements of two or more swimmers. Evaluating duet or team synchronisation to the music is aided by a tendency to use music with fairly strong rhythms to simplify timing of the actions. If the music is difficult to understand, credit must be given under Difficulty for the synchronisation.

4.2.1 One with the other

Members of a team or duet should be perfectly synchronised from the start to the finish, including movements under water. All body positions, movements and transitions should be perfectly synchronised. The swimmers should be synchronised above, at and below the surface of the water.



4.2.2 With the accompaniment

a) Types of synchronisation

The judge must consider whether the synchronising of the routine is to the rhythm, melody, accents or highlights and whether there is synchronisation with the special effects in the music, which may be used for spins, rockets, boosts, stacks, lifts and throws.

b) Tempo and tempo changes

Action should be related to the music's tempo and whether changes of the pace of movements occur in conjunction with the tempo changes.



5. JUDGING DIFFICULTY

Difficulty is the quality of being hard to achieve. Judging the difficulty of a routine is a complex task requiring a high level of knowledge and experience. The knowledge and understanding of factors governing the relative difficulties of various figure transitions must be applied to the analysis of all kinds of actions in the routines, not just the figures. There are two types of Difficulty, namely, difficulty of execution and of synchronisation.

5.1 DIFFICULTY OF EXECUTION

5.1.1 Figures and hybrid Figures

The difficulty of figures and hybrids is related to the amount of energy, power and strength, kinesthetic awareness, and/or technique proficiency needed to perform the movements, as well as the number and complexity of the combined actions.

a) Sustained airborne weight

All actions are more difficult when performed and sustained at maximum height levels. Difficulty is increased by having more body parts out of the water at the same time. For example, sustaining two legs with the knees water level is much more difficult than sustaining one leg at that level. A full twist at mid-calf height cannot be credited with the same difficulty as a full twist with a water level above the knees.

b) Length of exercise

Evaluation of the difficulty of long sequences should rest primarily upon the inherent complexity and physical stress of the sequence of actions and not upon the length of time underwater. Cumulative cardiovascular stress will increase the difficulty of performing even simple actions, but length of time underwater should not be considered a primary generator of difficulty.

c) Technique proficiency, scull proficiency

Difficulty increases with the inclusion of:

- hybrids that require a mastery of specialised skills, such as many rotations of spins, maintaining dynamic height, large travelled hybrid, and off-balanced hybrid
- hybrids that have a changing centre of gravity

d) Complexity, risk factors

Difficulty increases with the inclusion of:

- complicated hybrids that contain many parts
- multiple changes in body positions, angles, directions and water levels
- hybrid sequences with a large variation of pattern changes
- hybrid sequences in blind patterns or with blind pattern changes
- high-risk hybrids, e.g. a thrust followed by a rapid continuous spin, or rocket splits followed by multiple spins
- a connected move, especially when it is entered into from a blind move



Athletes may choose a routine composed of entirely 'safe' movements or may choose to use more difficult actions in which an error of execution or synchronisation may produce an appearance of near disaster.

A 'risky' routine using extreme thrust height followed by multiple spins, synchronising split rockets, boosts, lifts and coordinated platforms would increase the difficulty due to the added risk of major error. Failure in a risky action can also be sufficiently unnerving as to affect the balance of the routine. Successful risk elements in a routine can be rewarded with an added difficulty assessment. Failure to successfully execute the risk should not be rewarded with difficulty points for attempting it.

e) Flexibility

Difficulty increases with the inclusion of hybrid figures that require an extreme range of flexibility, such as Walkouts, Nova lift, Spiral lift, Aurora open, Knight and Split.

5.1.2 Strokes, propulsion techniques, transitions

The difficulty of strokes and propulsion is related to the amount of energy, power and strength needed to perform the movements, as well as their complexity.

a) Sustained airborne weight

The height of strokes and amount of weight held or carried above the surface add significantly to the difficulty. Arms should easily clear the water in horizontal stroking, with the body near or at the surface. Double-arm movements above the water increase the difficulty of the propulsion techniques.

b) Complexity

Difficulty increases with the inclusion of:

- complicated actions that contain many parts
- multiple changes in body positions, angles, directions and water levels
- actions with a large variation of pattern changes
- actions in blind patterns or with blind pattern changes
- very rapid, multiple quick movements to change arm, hand, leg or foot positions
- the complex combination of changing angles of the arms

c) Flexibility

Strokes that require an extreme range of flexibility, such as those with the extended arm behind the shoulder line, are also difficult.



5.1.3 Highlights, acrobatic movements

a) Acrobatic movements: platforms, stacks, lifts, throws, etc.

The risk of these movements is increased by:

- the number of swimmers or amount of weight lifted
- the length of time for which the position is held
- movements on top of the platform, such as leg lifts or splits, dance movements, off-balance movements and unstable positions
- throws from a platform, stack or lift
- maintaining the same position while travelling
- an unstable base
- a small base and supporting area

b) Floats and joined actions

The risk in these movements involves the possibility of failure to connect, particularly if minimal time is allotted for the connection.

5.1.4 Patterns and pattern changes

Patterns become more difficult by increasing the number of patterns and types of changes made, and due to the changing spatial relationship of the swimmers.

a) Establishing and maintaining a formation

Some patterns are more difficult to achieve and maintain than others. More difficult patterns include straight lines, diagonal lines, circles and other curves. Also, greater complexity and more frequent changes are associated with increased difficulty, and moving patterns are more difficult to maintain than stationary ones.

b) Types of pattern changes

Pattern changes are generally categorised into three types:

- 1) Blind pattern changes
- 2) Surface pattern changes
- 3) Underwater pattern changes

Blind pattern changes are more difficult to achieve and maintain than others. In blind pattern changes, the swimmers cannot see each other. The risk is particularly high for blind pattern changes requiring back-to-back movements, foot-first travel or maintaining a head-down, vertical position.

Surface changes are usually more difficult than those executed underwater, particularly when swimmers move in different directions. Pass-through pattern changes on the surface increase the difficulty involved in completing the movement with accuracy.



Judges should consider how swimmers move during a pattern change. A pattern change in which all swimmers move and change to another pattern is more difficult than one in which half of the swimmers are stationary and the other half participate in the change.

c) Number of pattern changes

A greater total number of pattern changes also increases the overall difficulty. The length of time for which a pattern should be held depends on the skill and experience of the swimmers, the type of action shown, and the music. Some top-ranked teams may execute pattern changes as frequently as every 5 seconds.

d) Proximity of swimmers to each other

Close spacing of swimmers restricts their freedom of movement and creates water turbulence and currents, which can add to the difficulty of the actions.

5.1.5 Placement of the difficulty actions

Placement of the actions in the routine may affect the overall difficulty. Difficulty increases:

- for a difficult figure when it follows another difficult figure or long underwater sequence
- when difficult figures are spaced throughout the routine
- when difficult figures are placed at the end of the routine

Outstanding swimmers with high tolerance of stress on the cardio-pulmonary system will be able to execute difficult movements in the last portion of the routine with the same degree of proficiency and effortlessness as shown at the beginning.

The best routines will include actions of high-level difficulty distributed throughout the routine from beginning to end.



5.2 DIFFICULTY OF SYNCHRONISATION

Difficulty comes from both from the movements chosen and how they are synchronised to the music.

5.2.1 Synchronisation of movements: number of swimmers

The more swimmers there are, the more difficult it becomes to align their movements perfectly, particularly with regard to:

- rates of rotation
- levels of descent of verticals and spins
- timing, height, width of opening and joining of a rocket split

Difficulty in the risk movement is increased by adding swimmers. The risk level for the same element is higher for a duet or team than in a Solo. Similarly, it is more risky to have all eight team members perform a continuous spin than to have four spin while the other four do something else.

5.2.2 Synchronisation with music: type of Music

Varying tempo, rhythm and melodic changes make some music more difficult than the standard 4/4, 3/4, or familiar repetitive pop tunes. Certain music becomes more difficult for synchronisation because accents or highlights demand that certain actions be executed at very specific times.

Judges must be cautioned not to allow the Execution score to influence their scores for Difficulty. Each must be considered separately.

6. GUIDING SCALE FOR DIFFICULTY

Difficulty of Execution			Extremely High Difficulty	Very High Difficulty	High Difficulty	Moderate Difficulty	Low Difficulty
Figures, hybrids	Sustained airborne weight	Airborne weight	Multiple elements on two legs	Several elements on two legs	Elements on either two legs or one, mostly one	Mostly one leg and vertical joint	One leg
		Length of exercise	Several very long	Multiple middle-length and long	Several middle-length and a few long with one leg	A few middle-length	Short
	Technique proficiency	Support, rotate, acceleration, travelling, maintain dynamic height, off-balance, Isolated	E.g. twist spin, combined spin, twirl spin, many rotations of spins, thrust hybrids, travelling, off-balanced, Isolated		E.g. spins, opening/closing	E.g. joined, simple rotation/spin	Simple joined
	Complexity, risk factors	Variation in body positions, angles, directions and water levels	Multiple angles and large variation of body positions in a hybrid; multiple hybrid sequence with large variation of pattern changes, including blind pattern changes; multiple sequences of complex and high-risk hybrids	Some angles in a hybrid; some hybrid sequences with blind pattern changes; multiple complex hybrid sequences; high-risk hybrids	Few angles in a hybrid; minimal changes of body positions; linear and simpler movements; less complex, simple blind hybrids	Minimal changes of body positions, mostly linear and in simpler sequences	Simple
Flexibility	Range of motion	Extremely large	Large	Moderate	Small	Small	
Strokes, propulsion	Sustained airborne weight	Airborne weight + length of exercise + travelling	Multiple sequences with both arms	Some sequences with both arms	Many with one arm or only the head, and some with both arms	Mostly with one arm or only head, and some with both arms	With one arm or only the head
	Complexity	Variations in body positions, angles, directions and water levels	Very complex	Somewhat complex	Moderate	Moderate to simple	Simple
	Flexibility	Range of motion	Extremely large	Large	Middle-level	Small	Small
Highlights, acrobatics (in Teams and Duets)	Complexity, risk factors	Overall	Very high risk, very complex	High risk, some complex	Middle-level risk	Some risk	Safe, simple
		Top					
		Base					
Patterns and pattern changes (mainly in Teams)	Establishing and maintaining a formation		Straight line, circle, curve			Box, two lines	
	Type of pattern changes	Blind pattern changes Surface pattern changes Underwater pattern changes	Multiple large variation of blind changes; large surface changes; all swimmers moved and changed; many pattern changes	Multiple middle-level variation of blind changes; large surface changes; many pattern changes	A few simple, small blind changes; lesser number of changes, mostly underwater	Mostly underwater changes, simple surface changes	Simple surface and underwater changes
	Proximity of swimmers		Close, small			Far, wide	
Placement of the difficulty actions			Well-balanced throughout a routine		Mostly in the beginning	In the beginning	

Difficulty of Synchronisation				
Synchronisation of movements (in Teams)	Number of swimmers	All swimmers		Fewer swimmers (divided into groups)
Synchronisation with music	Variation in tempo and pace	Complex, large variations		Simple, small variations
	Inconsistency of rhythm and tempo, unclear accents	Uncountable		Countable



7. JUDGING ARTISTIC IMPRESSION

Artistic Impression is an effect, image or feeling retained as a result of the demonstration of skill and good taste by the swimmer(s). The Artistic Impression score covers three areas: Choreography, Interpretation of Music and Manner of Presentation.

Because of the subjective nature of many elements in this component, wide latitude must be allowed. What may be considered artistic to one may seem common to another. An appreciation of a variety of cultures, styles, music types and interpretations should be cultivated. Personal feelings, i.e. whether one likes the routine or not, should not sway the judges' perception. Evaluations and scores awarded should be based on how the routine fits the judging criteria.

7.1 CHOREOGRAPHY

Choreography is the creative skill of composing a routine that combines artistic and technical elements. It involves the design and weaving together of variety and creativity of movements.

Choreography is defined as the art of assembling movements so that they have meaning, style and form. Creative and technical elements are assembled to construct a composition that has continuity, structure, purpose and meaning. The routine is not just a combination of unrelated actions. It should resemble a novel rather than a collection of short stories.

It is extremely important for the judge to retain an open mind and the ability to appreciate a variety of styles, even though he or she may prefer one style over another. When evaluating the choreography, the judge must consider the following areas.

7.1.1 Variety - diversity, assortment. The condition of being diverse.

The swimmer(s) should demonstrate a variety of body positions, figure movements, strokes, arm movements and propulsion techniques to demonstrate proficiency in the various Artistic Swimming skills. When demonstrating these skills, it is desirable to use a variety of levels of space. The swimmer(s) should show a balance of strokes, figures and propulsion techniques appropriate to the music. It is not necessary to include every skill, and some repetition may enhance the performance.

a) Strokes, propulsion techniques

Examples of positioning in these techniques include the following:

- arms may be bent, straight, angled or curved
- single or double arms
- hand and finger positions may be spread, flat, angled, cupped, straight, closed or curved
- head and body angles may tilt, turn, lift or stay erect
- height or body position changes can be made within a stroking sequence
- front to back to side
- horizontal to vertical and vice versa
- boosts
- flutter, eggbeater, scissors, whip, dolphin



b) Figures, hybrid figures,

Even more variations are possible in figures:

- body positions: layout, vertical, pike, tuck, split, bent knee, ballet leg, etc.
- standard and hybrid figures and transitions such as somersaults, walkouts, spins, rotations and thrusts
- multi-dimensional movements such as the Gaviata lift with rotation
- beginnings and endings can be varied with prone, supine and underwater actions
- figure completions include vertical descents, arch-outs to prone or supine positions, tucks and rolls and the currently popular splash-down endings
- innumerable combinations and hybrid figures can be executed, such as split rocket, walkover to spin and ibis to aurora
- ascending, descending, continuous open and closed spins, twirls and sustained rotations, all in a multitude of body positions and combinations

c) Transitions:

A variety of transitional actions should be employed when moving into and out of strokes and figures. These actions could include moving into a figure in a position other than prone or supine, such as the following:

- moving into a front pike from the side
- beginning a vertical from an underwater start
- a Nova arch start

Returning to the surface following a vertical descent can be varied by such features as tuck out, swim up, arch out, walk out and boost up.

Pattern change transitions can be made on the surface through stroking, kicking or eggbeater travel or from underwater by swimming, kicking or sculling up.

d) Speed, direction and level:

The speed of actions can change from fast to slow, accelerate or slow down, stop or become extremely rapid, and include 'frozen' moments.

Height of movement can vary from extremely high to the surface or underwater level.

Direction change can be from straight to side, to an angle, to turning, etc.

Direction may be forward, backward, sideways, head first or foot first.



e) Patterns and pattern changes:

Patterns and pattern changes can also vary:

- spread patterns and close formations
- curved lines and circles
- straight lines and diagonals
- moving or stationary patterns
- symmetric and asymmetric patterns
- box, diamond, triangle, V, X, cross

Groups in a team can be varied:

- all eight swimmers
- 4 and 4, 2-2-2-2, 3-2-3, 1-7, 2-6, etc.

7.1.2 Creativity - the act of being original or imaginative.

Creativity should be considered in the broad sense of making something out-of-the-ordinary, something unexpected or surprising. It may entail combining or changing familiar material to offer something unique, or it may be the way in which music is used to make something happen to cause an element of surprise, or to replace the obvious stereotype with the unexpected. The meaning of *creative* should not be restricted to *original*, but instead should be understood as the making of a lasting impression, something truly unique, a 'memorable moment'.

In Duets and Teams, the connections between swimmers may add to the creativity of the choreography.

The routine may also demonstrate a creative use of the music. This refers to using the music in an appropriate manner but other than the expected stereotype for the music used.

Look for creativity in all actions: figures, strokes, propulsion techniques, transitions, patterns and pattern changes, paired and group actions. A superior routine will use a wide variety of creative movements and patterns.

a) Uniqueness

Look for unique, unusual, innovative, out-of-the-ordinary, surprising or unexpected actions.

b) Paired and team actions

These may include joined or intertwined movements in pairs or groups, floats and connected actions, lifts, throws (such as somersaults in the air) and platforms with statues.



c) Highlights and memorable moments

In addition to the above, memorable moments may come from:

- a combination of actions
- rapidly changing combinations of float sequences
- combinations of figure and/or stroke sequences
- peel-off or add-on cadence actions
- exciting figure actions such as split rockets, rocket thrusts, thrust spins or open and closed multiple spins of varying tempos.

Look for movements that are distinctive!

7.1.3 Pool coverage, pool pattern

Pool coverage or pool pattern is described as the area through which the swimmers move or the pathway the swimmer takes through the water. Constant travel throughout the routine is desired. How the swimmers move throughout the pool area and the pattern of movement they create should be major considerations.

A well-choreographed routine will be constantly moving and will cover the whole pool. In a routine with good pool coverage, swimmers will avoid spending extended periods of time in a small area of the pool.

a) Constant flowing action

Routines travel the length, on angles, to corners and sides of the pool while moving in and out of patterns. The flow should continue without abrupt stops, reverse actions or retracing paths unless they are for choreographic effect. Time spent in any one spot should be minimal.

b) Effective use of space

Although the space should be effectively used for movement to cover all areas of the pool, consideration should also be given to the placement of highlights and special actions. These special actions should be placed where they can be effectively seen and appreciated.



7.2 MUSIC INTERPRETATION

Music Interpretation means expressing the mood of the music, making use of the music's structure.

Use of the music should be judged with an open mind, allowing for a wide latitude of individual interpretation. The use of music refers to how the swimmer(s) use the structure of the music.

Music actually has a far greater influence because the music is the basis for all the other categories. Choreography is dependent upon it; Manner of Presentation relates to the feeling the swimmer has for the music; and all the technical categories (Execution, Synchronisation and Difficulty) are affected by how the music is used. Using music effectively should be thought of as the blending of movements and music into an oneness of expression.

In the Solo event, when use and interpretation of the music are done to perfection, it will appear as if the soloist and her music are one. It is as though the music was written for her.

7.2.1 Interpretation of character, mood, feeling

Music Interpretation in Artistic Swimming means the translation of sounds, rhythms, dynamics, melodies, moods, accents and highlights in the music to suitable expression of movement in water. The nature of the music, from full symphonic orchestration to a single violin concerto, from symphonic choral works to pop ballads, determines the type of action that can be used to express its mood and the emotional responses needed for its portrayal.

Music may range from strong, forceful, staccato and loud to soft, subdued, delicate and flowing. Strong, dynamic music calls for powerful, grandiose actions and movements. Soft, flowing music calls for a more lyrical interpretation with rounder, more fluid and delicate actions. Fast, quick, complex movements fit music with a fast tempo, whereas slow, graceful movements must be created for slower passages. The mood of the music may induce tension or excitement, joy or tranquillity in the listener. Some music calls for continuous flowing action; other music has stops and starts demanding intermittent or staccato action. The nature and demands of the music should all be found in the competitor's portrayal of it.

a) Character, quality

Consider the sound: full symphonic orchestration or single instrument; pop vocal or military band; chamber quartet to rock band; strident, overriding beats or soft, flowing melody. Then consider whether the character of the music has been portrayed by the movements in the water.

b) Mood, meaning

Consider the mood or meaning of the music, strong: romantic, joyous, sorrowful, patriotic, etc. Perhaps you know what the composer had in mind. If not, what does it 'say' to you? Consider both the obvious and subtle qualities of the music and whether they have been interpreted.



c) Feeling, fervour and passion

Consider the emotional impact of the music and how it has been interpreted. The athlete must be able to bring out the emotion heard by the viewers through the interpretation given.

7.2.2 Use of the music's dynamics

The term 'use' means 'availing oneself of something as a means to an end'. The music's rhythms, dynamics and accent points set the tempo and power for the actions. Literally, use of the music is how the swimmers use the beats and measures, the 'highs and lows', varying melodic themes, different instrumental sounds, and the dynamic changes (highlights and accent points).

Highlights or accent points in the music call for something special such as boosts, platforms, lifts, throws, split rockets, multiple spins, etc. A superior routine will always match the highlights to the special accents in the music. These are the memorable moments that remain with the viewers.

a) Tempo changes

Actions must match the tempo—fast, moderate, slow or stopped—and change when the music does.

b) Power and delicacy

Movements match the strength and delicacy heard. Strong, angular and forceful actions are used for dynamic music. Flowing, curving, soft actions are best for lyrical, melodious parts. The highs and lows in the music are matched by actions, up high or low in the water.

c) Accents and highlights

Memorable moments are matched to the accents and highlights in the music—the crescendos and decrescendos, big cymbal clangs, drum rolls, etc.



7.3 MANNER OF PRESENTATION

Manner of Presentation is the manner in which the swimmer or swimmers present the routine to the viewers. Manner of presentation is more than a smile. It involves the face and use of the whole body. The swimmers must demonstrate that they are in total command throughout. The impression is one of a richness of movement, with the swimmers 'owning the water'. Total command requires a completeness of performance that demonstrates confidence, poise and effortlessness; a high energy level, both physical and emotional; and consistency of performance with the maintenance of an illusion of ease throughout. There must be responsiveness to the emotions expressed by the music and appropriate to the choreography, along with the ability to communicate with sincerity and enjoyment to viewers so that they are drawn into and feel as if they are a part of the performance.

Routines that receive top scores in this category show dynamism and strength yet are also fluid, graceful and captivating. They have an allure, an appeal to the senses, a magnetism; in short, they have charisma.

a) Completeness of performance

Use of whole body, body language

Superior athletes will demonstrate excellent carriage and posture and be able to display and make use of body language in head and torso positions, in leg, arm and hand movements and in facial expressions, to carry a message to the viewers.

Focus of body and face

Look for eye contact and use of the head. The focus can be erect and upright, with straight or squared shoulders, or it may be soft, curving, turning with tilting shoulders and accompanied by appropriate facial expressions to carry a message to the viewers.

Use of varied moods

The athlete should be able to demonstrate a desired mood (love, power, joy, sorrow, anger, pain, etc.) so as to allow the audience to also feel the emotions heard in the music.

b) Aura of total command, confidence

Convincing presentation

The entire performance should be purposeful, riveting and demanding attention, with an air of confidence and command maintained throughout.

Although not considered in the scoring, the initial appearance (walk-on and deck positions) should be assured, with sharp, clear and commanding positioning. The ending position should also be sharp, clear and commanding.

The performance should seem fresh and spontaneous throughout!



c) Effortlessness throughout

An illusion of ease should be maintained throughout the performance. The breathing should be quiet and not explosive or wheezing. The kicking and sculling should appear effortless and powerful without splash or struggle. Figures should remain high, stable and executed cleanly to completion. The return to the surface and 'break-through' should be smooth and easy, without sputtering, blowing bubbles or fountains of water. The athlete should not look frantic or panicky and should remain poised and confident throughout.

Consistency of performance with continual movement

Top swimmers will not look rushed or exhausted, but will demonstrate a consistency in their level of performance from start to finish. The routine will flow seamlessly, with continual movement throughout, so that the viewer is led from one action to the next, never able to look away even momentarily because there are no stops or resting points where movement lags.

d) Charisma and communication

Ability to communicate with viewers

The personal presence of the swimmer(s) can be captivating, enchanting, intriguing, fascinating, etc. The routine seems too short when it is done so well.

Facial expressions

If the mood of the music changes, so may the facial expressions. A 'pasted-on' smile is seldom appropriate, especially if the feeling of the music is serious, strong, angry or sad and sorrowful. Throughout the routine, the swimmer or swimmers need to portray confidence and at ease in all their movements.

Sincerity

To be convincing, athletes should be able to establish eye contact with the judges and audience.

Showmanship

The terms *magnetism*, *charm*, *appeal* and *charisma* signify how the athlete projects to the audience. Swimmers must 'sell' their performance every time it is executed, always appearing new and fresh. Each performance should bring obvious enjoyment eliciting spontaneous applause from the viewers. You could watch it again and again.



8. EXPANDED MARKING SCALE FOR ROUTINES – EX, DIF

	Execution		Difficulty
	Execution	Synchronisation	
	<i>The level of excellence in performing highly specialised skills. Execution of all movements.</i>	<i>The precision of movements in unison, one with the other and with the accompaniment when above, at and below the surface. Synchronisation of timing of one with another and with the music.</i>	<i>The quality of being hard to achieve. Difficulty of all movements and of synchronisation.</i>
Perfect: 10			
Strokes & Propulsion	Maximum height, extension, fluidity and power in all parts of the routine. Whole body used in execution of strokes. Head first boost crotch height. Angles perfectly matched.	Totally synchronised with the music and each other. Absolute precision throughout. Angles perfectly matched while performing the movements.	Sustained height with maximum weight out of water, extreme flexibility, power. Complex arm angles and multiple sequences using both arms. Strong complex propulsion with maximum speed of movement.
Figures & Hybrids	Maximum height, complete extension, accurate angles. Extreme flexibility. Refer to the Height Chart.	Totally synchronised in all aspects. Absolute precision throughout. Angles perfectly matched while performing the movements.	Exceptional difficulty. Sustained airborne maximum height, maximum dynamic height, complex leg angles, isolation moves and combinations of actions. Difficulty throughout routine. High risk.
Transitions	Exceptional power and efficiency. Maximum distance covered.	Totally synchronised in all aspects. Absolute precision throughout.	Continuous complex moves with maximum power.
Patterns	Clear, accurate, even spacing between swimmers throughout the routine.	Totally synchronised in all aspects. Absolute precision throughout.	Complex, intricate patterns with frequent changes. Blind pattern changes. Very close spacing. Intricate synchronisation.
Highlights	Throws: maximum height, clean entries. Platforms: High, stable. Precise and accurate angles and movements.	Totally synchronised from set up to completion of all moves including the entry. Perfect synchronisation to the music.	Extremely complex. Minimal set up and recovery time. Set ups use an unstable or small base. Complex lengthy actions in the air or on the platform using off-balance and unstable moves. High risk.
Near Perfect: 9.5 - 9.9			
Strokes & Propulsion	Near flawless with near maximum height with <u>minute</u> deviations. Solid and high. Extension, fluidity and power evident throughout. Effort is not apparent. A few slight deviations visible only to the 'trained' eye.	Near flawless. <u>Minute</u> errors. Slight variations in timing of kicks and/or transitions.	<u>Minute</u> deviations in difficulty. Sustained near maximum height. Flexible, powerful, complex arm angles and multiple sequences using both arms. Strong complex propulsion with near maximum speed of movement.



	Execution		Difficulty
	Execution	Synchronisation	
Near Perfect: 9.5 - 9.9			
Figures & Hybrids	Almost flawless. Almost maximum height in all figures and hybrids. <u>Minute</u> differences in water levels between swimmers in duet and team. <u>Minute</u> deviations from perfection. Refer to the Height Chart.	Almost flawless. <u>Minute</u> deviations in timing that are visible only to the 'trained' eye. <u>Minute</u> differences in leg angles between swimmers in duet and team while performing the movements.	Extreme difficulty with <u>minute</u> deviations. Sustained near maximum airborne height and dynamic height showing <u>minute</u> differences in flexibility and range of movement. Complex off-balance leg angles, isolation moves, multiple rotations and combinations of actions throughout. High risk.
Transitions	Power & control demonstrated but may not cover maximum distance.	Almost flawless. <u>Minute</u> errors in timing of transitions.	<u>Minute</u> deviations in difficulty of transitions.
Patterns	<u>Minute</u> errors in pattern formations and changes.	<u>Minute</u> differences into or out of transitions.	Complex and frequent pattern changes, many blind changes, many close patterns and intricate synchronisation required. High risk.
Highlights	Throws: near maximum height. Clean entries. Platforms: High, stable. Precise and accurate angles and movements.	<u>Minute</u> deviations in synchronisation from set up to completion of all moves including the entry. <u>Minute</u> synchronisation variances to the music.	Complex actions in the movements and precision required for entries into the water. Minimal set up and recovery time. Some set ups use an unstable or small base. Mostly complex lengthy actions in the air or on the platform using off-balance and unstable moves. Short setup and recovery time. High risk.
NB: 'Minute' errors or deviations are seen only by a trained eye and are seldom apparent to an uninformed observer.			
Excellent: 9.0 - 9.4			
Strokes & Propulsion	Strong, powerful and high. Effective propulsion with some loss of distance travelled. A few <u>minor</u> errors.	Actions are sharp and precise with the music. Very few <u>minor</u> errors scattered throughout. Excellent synchronisation to music that is difficult to count.	Complex actions with very few <u>minor</u> breaks in difficulty of arm sequences with airborne weight and length of exercise. Strong propulsion with minor breaks of power and speed.
Figures & Hybrids	Solid, close to maximum height with minimal level changes. A few <u>minor</u> but not significant differences in leg angles, lines of transition, water levels, fluidity & clarity. Refer to the Height Chart.	Sharp and precise with the music. A very few <u>minor</u> errors scattered throughout.	Extreme difficulty with very few <u>minor</u> breaks in achieving maximum height on sustained airborne and dynamic height. Minor breaks in difficulty but demonstrates many complex off-balance leg angles, isolation moves, multiple rotations and combinations of actions. High risk.



	Execution		Difficulty
	Execution	Synchronisation	
Excellent: 9.0 - 9.4			
Transitions	Strong and powerful.	Very few <u>minor</u> errors. <u>Minor</u> differences in surfacing and in performing rapid movements.	Very few <u>minor</u> breaks in difficulty of transitions.
Patterns	Patterns mainly accurate with <u>very minor</u> loss of the perfect shape. Spacing usually excellent.	Sharp and precise. Very few <u>minor</u> errors in achieving timing into patterns.	Complex pattern changes with swimmers in close proximity and frequently changing. Some blind pattern changes. Intricate synchronisation. Some risk to achieve accuracy.
Highlights	Throws: near maximum height. Mostly clean entries. Platforms: High, stable. Very few <u>minor</u> differences in angles and movements.	Very few <u>minor</u> differences in synchronisation from set up to completion of all moves including the entry.	Some extremely high risk and very complex actions with clean, controlled entries. Very short setup and recovery time.
Very Good: 8.0 - 8.9			
Strokes & Propulsion	Generally high with some minor differences in arm angles. Propulsion generally effective.	Minor errors in precision of timing. Timing with music very good. Very good synchronisation to music that is difficult to count.	Well balanced throughout routine. Some sequences using both arms, some complexity of moves showing different angles. Minor breaks in intensity.
Figures & Hybrids	Most positions are clear and accurate with minor inaccuracies in position, stability and/or control. High, but may lose height on difficult parts, not always uniform. Well extended. Refer to Height Chart.	<u>Minor errors.</u> Precision of timing slightly off in parts of the routine. Fast movements may appear slight synchronisation at times.	Very high difficulty in some figures showing sustained airborne height and complex actions. Demonstrates some complex off-balance leg angles, isolation moves, multiple rotations and combinations of actions. Difficulty may be restricted to certain actions and is more widely spaced. Some high risk.
Transitions	Generally strong and powerful.	<u>Minor</u> errors, surfacing may be slightly different.	Lacks some difficulty and complexity in transitions.
Patterns	All patterns clear and mainly precise, small deviations in achieving patterns.	Few errors in getting into and out of patterns.	Frequent difficult pattern changes with swimmers generally in close proximity.
Highlights	Throws and platforms are generally high, stable and convincing. Platforms are generally high and stable.	<u>Minor</u> differences in synchronisation from set up to completion of all moves including the entry.	Generally performs high risk moves with some complexity. Difficulty is spread throughout the routine.



	Execution		Difficulty
	Execution	Synchronisation	
Good: 7.0 - 7.9			
Strokes & Propulsion	Strokes are precise and fairly high in easier parts. Height sometimes unstable.	A few obvious errors but most errors are <u>minor</u> . Lacks crispness and precision. Well synchronised to music that is easy to count.	<u>Medium</u> difficulty mainly at the beginning and scattered throughout. Many one arm or head only moves, some double arms.
Figures & Hybrids	Above average figures usually clear and fairly high. Height sometimes unstable. Power, height and propulsion may deteriorate. Loses height and effort is evident in difficult parts. Full extension not maintained throughout. Refer to the Height Chart.	A few obvious errors. Lacks crispness and precision.	<u>Medium</u> difficulty mainly at the beginning and scattered through. Limited to elements in which swimmers are most comfortable. Mostly single leg actions with few angles and change in body positions. <u>Medium</u> length figures with moderate range of flexibility. In team, many figures not performed by all swimmers.
Transitions	Lacks strong power and there may be pauses between actions.	Generally well synchronised but some errors in finishing and starting actions in duet and team.	Basic actions between movements. <u>Medium</u> difficulty.
Patterns	Most patterns clear and precise, small deviations in achieving positions in the patterns.	Some obvious errors in synchronisation to achieve pattern positions.	Simple, small blind changes, limited number of pattern changes and more underwater changes than at the surface.
Highlights	<u>Medium</u> height and lacking some accuracy in positions. Stability not maintained throughout. Obvious effort to achieve one or more highlights.	Not all swimmers may be synchronised at times in the routine. Some obvious errors in timing of actions. Generally synchronised with the music.	<u>Medium</u> level risk moves with less complexity in positions, sequences and length of action. Small number of rotations, off-balance and airborne weight moves.
Competent: 6.0 - 6.9			
Strokes & Propulsion	All strokes/arm actions are clear and precise showing basic power. Some rest spots.	<u>Minor</u> errors throughout. One or two swimmers may be 'out' in team. Lacks sharpness. Music is basic 1,2,3,4 counting.	Mostly one arm or head only moves with moderate complexity. Small range of flexibility to music that is easy to count.
Figures & Hybrids	<u>Average</u> height with minor inaccuracies especially in difficult parts. Slurring of positions and transitions. Lacks stability and control in difficult parts. Timing may be hurried. Refer to Height Chart.	<u>Minor</u> errors throughout. One or more swimmers may be 'out' in team. Lacks sharpness. Surfacing may be at different times in duet and team.	More difficulty at the beginning. Mostly short, linear & single leg actions with minimal change in body positions. Small range of flexibility. In team, several figures are not performed by all swimmers.



	Execution		Difficulty
	Execution	Synchronisation	
Competent: 6.0 - 6.9			
Transitions	Average height with pauses between actions. Lacks power and efficiency.	Most actions are synchronised with the music. <u>Minor</u> errors in timing between swimmers.	Simple transitions performed to music that is easy to count.
Patterns	Patterns are not all clear or accurate and spacing is uneven. Swimmers are often far apart from one another.	Transitions into and out of patterns is not clear. Lacks precision.	Basic patterns with mostly underwater changes or simple surface changes. Rest spots and visual checks evident.
Highlights	Average height with inaccurate achievement of positions. Lacks energy and power in moves. Entries not always clean.	Not all swimmers are synchronised. Minor timing errors from beginning to end.	Some risk, simple sequences lacking in complexity of action with limited variations in body position and minimal rotations.
Satisfactory: 5.0 - 5.9			
Strokes & Propulsion	Strokes are not well defined and angles are inaccurate. Propulsion is not strong or efficient and swimmer(s) do not cover the pool.	Some <u>moderate to major</u> errors. Precise timing is lacking and movements lack precision. No attempt to synchronise underwater.	One arm or head only short, simple moves. Small range of flexibility to music that is easy to count.
Figures & Hybrids	Many problems showing accuracy and clarity in positions. <u>Some major</u> errors. Minimal control with effort evident throughout. Minimal extension and often rushed and segmented. Refer to the Height Chart.	Some <u>moderate or major</u> timing errors. Precise timing is lacking in achieving all positions in figures/hybrids. .	Short, simple one leg figures with a small range of flexibility. Actions are limited to what the swimmers are able to achieve.
Transitions	Some height in easier sections. Lacks power and efficiency.	Obvious errors in timing before and after movements and there is little relationship to music.	<u>Basic</u> transitions that lack flow and is performed to music that is easy to count.
Patterns	Patterns are generally not clear, are widely spaced and are not efficiently achieved.	Pattern changes and going into and out of the pattern are not synchronised.	Widely spaced patterns. Easy pattern changes. Lots of time to check patterns. Mainly underwater pattern changes.
Highlights	Highlights are attempted but they are low and unstable. Throws are attempted but they are low over water. Lack clarity of definition.	Poorly synchronised so they may appear very inaccurately executed. O one or more swimmers are "out" in timing in team.	Highlights are safe and simple with long setup and recovery time. Risk elements are limited to those that do not require height.



	Execution		Difficulty
	Execution	Synchronisation	
Deficient: 4.0 - 4.9			
Strokes & Propulsion	Limited propulsion and swimmers do not cover the pool due to lack of power and efficiency. May be limited to one side of the pool. Arm actions lack definition.	Major synchronisation errors in stroke actions. Propulsion is different so positions are constantly unclear.	Basic stroke combinations. Small range of flexibility to music that is easy to count.
Figures & Hybrids	Height is low and inconsistent. Many <u>major problems</u> in achieving positions. Unstable, loses control in many parts. Struggling. Poor extension. Rushed and uneven. Refer to Height Chart.	Attempts to synchronise but <u>major errors</u> throughout. Little synchronisation other than with the obvious beat of music.	Very short figures. No sustained vertical figures.
Transitions	Poor flow between actions. Movements are not finished.	Little relationship with the music or with each other. Swimmers may be moving in different directions.	<u>Simple</u> transitions.
Patterns	Patterns are large and often unclear. One or more swimmers may be obviously out of pattern.	Patterns are unclear. Very poor attempt to synchronise transitions in and out of patterns.	<u>Simple</u> patterns, few pattern changes and are held for a long time. More pattern changes are underwater than at the surface.
Highlights	Highlights may be attempted but they are very low and/or unstable.	Movements are unsynchronised resulting in highlights generally being unsuccessful.	Simple highlights are attempted. These may be floating pattern changes.
Weak: 3.0 - 3.9			
Strokes & Propulsion	Major differences in arm actions. Angles are very different between swimmers in duet and team. Propulsion is weak or inadequate. Little power and pool coverage.	Timing of all actions are different and have little relationship to music.	Simple strokes and propulsive techniques.
Figures & Hybrids	Struggling in all aspects. <u>Low</u> height. Unclear what the swimmers are performing. Very inaccurate positions with limited attention to transitions. Unclear and poor extension. Refer to Height Chart.	Timing of all actions different. There is an attempt to synchronise but seldom together. Uneven timing.	Short, simple actions. Very short figures: e.g. bent knee positions, somersaults, etc.
Transitions	Unclear, no clarity in executing transitions.	Little synchronisation between other swimmers or with the music.	Basic actions only.
Patterns	Patterns are unclear and widely spread.	Little synchronisation into, within and out of patterns.	Simple with infrequent changes.
Highlights	Highlights are very unstable or do not work.	Lack of synchronisation with each other and/or to the music.	Minimal (if any) very basic highlights attempted.



	Execution		Difficulty
	Execution	Synchronisation	
Very Weak: 2.0 - 2.9			
Strokes & Propulsion	Very low height. Swimming skills are extremely weak not allowing for propulsion. Very limited pool coverage.	Very little or no synchronisation between the swimmers and/or to the music.	Basic strokes and propulsive techniques.
Figures & Hybrids	All positions are poorly defined. Extension is totally lacking. Very low height throughout. Struggling to execute even basic actions.	Very little or no synchronisation between the swimmers and/or to the music.	Surface figures and basic somersaults. Mainly floating actions.
Transitions	Gaps in transitions. Little control over legs and arms.	Poor synchronisation into and out of movements.	Simple transitions. Long pauses between movements. Lots of layouts and rest periods.
Patterns	Generally unrecognizable.	Little or no synchronization into, during or out of pattern.	Simple with minimal if any change.
Highlights	Very messy and unclear. There may be no highlights or they are unrecognizable. Lack any height. Generally fail.	Little or no synchronisation into, during or out of the highlights.	Likely will not be attempted or a basic floating pattern.
Hardly Recognizable: 0.1 - 1.9			
Strokes & Propulsion	Lacking any precision in basic strokes. Extremely limited pool coverage. Extremely weak.	No apparent relationship between swimming to each other and/or to the music.	Simple strokes and sculls.
Figures & Hybrids	Lacking all technical skill so movements are hardly recognizable. Struggling to perform all figures and hybrids. Little if any height.	Very little if any attempt to synchronise with the music and/or each other.	Very little content. Short figures/hybrids. Simple movements.
Transitions	Transitions are very poorly executed, and lack clarity.	Very little if any attempt to synchronise with the music and/or each other.	Big gaps between actions. Simple changes between actions.
Patterns	Patterns are hardly recognizable.	Patterns are not synchronised at all.	Very simple with minimal if any change.
Highlights	If present they are hardly recognisable except at surface.	Very little or no attempt to synchronise with the music and/or each other.	Likely are not attempted or a very basic floating pattern.



EXPANDED MARKING SCALE FOR ROUTINES - AI

Artistic Impression		
Choreography	Music Interpretation	Manner of Presentation
<i>The creative skill of composing a routine that combines artistic and technical elements. The design and weaving together of variety and creativity of all movements.</i>	<i>Expressing the mood of the music, use of the music's structure.</i>	<i>The manner in which the swimmer(s) present(s) the routine to the viewers. The total command of the performance of the routine.</i>
Perfect: 10		
Extremely captivating, creative and innovative. Whole routine is memorable. Perfectly cohesive and balanced structure. Extensive variety of hybrids, strokes and highlights. Numerous and fluid creative pattern changes. All areas of pool are covered and the choreography is designed to showcase the creative movements.	Elements of surprise and uniqueness with use of music. Totally at one with the music. Movements used obviously require this particular music throughout. Swimmers express both obvious and subtle qualities of the music and take advantage of <i>all</i> the musical elements to achieve an emotional impact. Leaves a lasting impression with this piece of music.	Total command, compelling attention. The viewers and judges can't take their eyes off the routine. More of an experience than just a routine. Projects personality and involves all viewers. Charismatic. Completely poised & confident. Each performance appears fresh. Total body used for expression.
Near Perfect: 9.5 - 9.9		
Captivating, creative and innovative throughout. <u>Multiple</u> memorable moments. Cohesive & balanced structure Wide variety of hybrids, strokes and highlights throughout the routine. Numerous and fluid creative pattern changes All areas of pool are covered.	Near perfect use of all the qualities within the music. Swimmers express both obvious and subtle qualities of the music. Multiple memorable moments. Strong emotional impact.	Unique and special to these swimmers. Captivating with a strong emotional impact. Hard to imagine others swimming this routine.
Excellent: 9.0 - 9.4		
Mostly captivating, creative and innovative. <u>Multiple</u> memorable moments with very <u>minor</u> breaks preventing it from being truly special and unique. Wide variety of hybrids, strokes and highlights throughout the routine. Numerous and fluid creative pattern changes. All areas of pool are covered	The majority of parts have a strong impact on the viewer. <u>Minor</u> breaks in intensity and completeness of use of music and interpretation. Multiple memorable moments.	Confident and appealing, but with occasional <u>very minor</u> breaks in projection and focus. Explores the mood/theme through expression using whole body. Emotional energy.



Artistic Impression		
Choreography	Music Interpretation	Manner of Presentation
Very Good: 8.0 - 8.9		
<p>Strong choreography with very good range of creativity in strokes/figures and hybrids. <u>Minor gaps</u> in creativity. <u>Several</u> memorable moments. Some elements may be poorly placed or the routine may be unbalanced. Highlights demonstrated throughout <u>most</u> of the routine but may have a limited range and variety of techniques. Frequent pattern changes but flow may not be maintained throughout. A few areas of the pool may be missed.</p>	<p>Movements match mood and pace. Expresses <u>most</u> musical qualities but may miss minor opportunities. Very good use of the obvious accents. <u>Several</u> memorable moments.</p>	<p>Confident and explores the mood/theme through expression using whole body. Occasional lack of focus or not exploiting every opportunity to gain attention. Emotional energy demonstrated in most parts of the routine.</p>
Good: 7.0 - 7.9		
<p>Good routine with mainly standard actions lacking some creativity and variety. <u>Some</u> creative sections but unbalanced with limited variety and <u>gaps</u> evident in strokes/figures and hybrids. <u>Some</u> memorable moments. Mostly standard highlights with basic actions demonstrated throughout <u>some</u> of the routine but are lacking in variety and uniqueness. Frequent standard pattern changes with some lack of creativity and flow. Pool coverage misses some areas.</p>	<p>Actions generally fit the music. Explores the use of both melody and rhythm. Attempts to explore the theme or mood. Some emotional appeal is lacking. <u>Some</u> memorable moments.</p>	<p>Some command but may lack physical and/or emotional energy. Focus can be 'on' or 'off' Lack of precision in all movements affects the presentation.</p>



Artistic Impression		
Choreography	Music Interpretation	Manner of Presentation
	Competent: 6.0 - 6.9	
<p>Basic, predictable and ordinary choreography. <u>Few</u> creative moments. Some variety in strokes/figures hybrid but generally lacking originality and creativity. <u>Few</u> memorable moments. Minimal highlights are <u>scattered</u> throughout in the routine lacking creativity and variety. Limited number of predictable, and repetitive basic pattern changes. Pool coverage misses several areas or limited to one side of the pool.</p>	<p>Most actions fit the music. Predictable use of the obvious rhythm or melody. <u>Some</u> attempt to project mood or theme. <u>Few</u> memorable moments</p>	<p>Swimmers may attempt to make eye contact and communicate with judges but this tends to be erratic and may not be present in all swimmers. Lacks physical and emotional energy.</p>
	Satisfactory: 5.0 - 5.9	
<p>Common repetitive basic actions with <u>limited</u> variety in strokes, figures and hybrids. Highlights if any, lack creativity and variety. <u>Limited</u> repetitive pattern changes lacking flow. Pool coverage is unbalanced and limited.</p>	<p><u>Some</u> actions fit the music. Mechanical use of the obvious beats of the music. Repetitive, common and basic actions for easy to use accents.</p>	<p>Little effort to project and make eye contact with judges. Most focus is inward concentrating on performance of skills. Lacks physical and emotional energy.</p>
	Deficient: 4.0 - 4.9	
<p>Basic routine with <u>very limited</u> variety of strokes, figures and hybrids. Very limited simple basic repetitious pattern changes lacking flow. Pool coverage is <u>very limited</u>.</p>	<p>Few actions fit the music. Uses the obvious beat of the music but mood and character are ignored.</p>	<p>No effort to project and make eye contact with judges. Swimmers may appear scared or generally unaware of the audience.</p>
	Weak: 3.0 - 3.9	
<p>Limited routine with a series of basic skills and propulsive techniques. Some attempt at patterns in team. Lacking flow between movements. No logical pattern flow or pool coverage.</p>	<p>Actions do not fit the music. Attempts to use the music. Only the simplest beat used. Music is mostly background.</p>	<p>Almost total inward focus. In Duets and Teams, look more at each other than at the viewers.</p>



Artistic Impression		
Choreography	Music Interpretation	Manner of Presentation
	Very Weak: 2.0 - 2.9	
Routine has little evidence of a plan or structure. A sequence of simple very basic moves. Patterns in team are very weak and hard to identify. Little pool coverage.	No interpretation of the music. Any music could be used.	Awkward. No attempt at presentation. Totally inward focused and unaware of judges or viewers.
	Hardly Recognizable: 0.1 - 1.9	
Does not resemble a routine and has no structure. Simple basic moves scattered. Patterns in teams, if any are hardly recognizable. Little if any pool coverage. Choreography is limited to swimmers abilities.	Swimmers are swimming and music playing but there is no link.	Attempting to swim. No awareness of judges or viewers.



C. FREE COMBINATION

The Free Combination must have eight (8) to ten (10) competitors who make a combination of routines choreographed to music. (AS 4.4)

FINA REQUIRED ELEMENTS FOR THE FREE COMBINATION (Appendix VII)

GENERAL REQUIREMENTS

1. Time limits as in AS 14.1
2. Start may be on the deck or in the water.
3. Start of the first part of the routine must start from in the water after the deck work.
4. The new part begins in close proximity to the previous part.

REQUIRED ELEMENTS

At least two (2) parts must have fewer than three (3) competitors and at least two (2) parts must have eight (8) to ten (10) competitors

For the two (2) or more parts to be considered having fewer than three (3) competitors, all remaining competitors must be still or maintaining a pose. There is no required time length but a minimum of 3 seconds is a suggested guideline.

The intent of the Free Combination Routine is to be *free* with limited rules and regulations.

The term “**Parts**” refers to the various sections with different numbers of competitors that make up the combination routine.

The term “**Exchanges**” refers to the switching from one part to the next part.

The exchanges can be viewed as the glue to fitting the parts of the puzzle together seamlessly to make a whole cohesive fluent and artistically meaningful routine.

The general requirements state a new part begins in very close proximity to the previous part. How far is acceptable?

- The intention is that the routine should flow and be logical not requiring the judges or T.V. cameras to search for the next competitor.
- The distance must be safe for the competitors. (especially for team exchanges)
- Obvious distance between exchanges will affect the fluidity of the routine and therefore the judges score and will be subject to a penalty based on the referee’s decision.



Three (3) panels of five (5) judges will officiate and provide one score as follows:

- Panel One -Execution
- Panel Two -Artistic Impression
- Panel Three -Difficulty

Panel 1 – AS 17.2.1 EXECUTION SCORE – 30%

Consider:	
Execution – the level of excellence in performing highly specialized skills.	50%
Synchronisation – the precision of movement in unison, one with the other, and the accompaniment above, at and below the surface. Timing of one with another and with music.	50%

ADDITIONAL FACTORS SPECIFIC TO THE FREE COMBINATION ROUTINE

EXECUTION: Consider how well each part and exchange of the routine is performed

- Does the level of execution change within parts or vary as the routine goes on?
- Are the parts with less than 3 competitors performed better than the parts with 4 or more competitors or vice versa?
- How is the execution performance ending one part and starting into the next part?
- Does it flow smoothly and start where the last part finished?
- How clear are the pattern formations between exchanges?

SYNCHRONISATION: One with the other and with music in parts and exchanges

- Are the exchanges between parts clearly synchronised?
- Consider the synchronisation of the exchange movements surfacing, descending, above and below the water.



EXECUTION: Free Combination Routine EXCHANGES

9's Excellent – Near Perfect	Almost flawless exchanges-solid, high & effortless Minute synchronisation variations and errors in kicks or transitions most likely evident in team
8's Very Good	No major errors , strong & high throughout exchanges, but may lack fluidity Synchronisation is sharp and mostly together with only minor errors evident
7's Good	One or two major execution errors. Effort is evident with actions usually clear and fairly high, but power, height and propulsion may deteriorate within the exchanges as the routine progresses Synchronisation could be crisper and more precise in timing, but no major synchronisation errors
6's Competent	Variable performance, medium height, lack of power in and out of exchanges, hard to follow patterns and transitions. Few major errors (3 or 4) Synchronisation errors are evident with differences in timing most evident in team exchanges (many minor but not more than 1 or 2 major)
5's Satisfactory	Some major errors (4 to 6) and many minor execution errors in exchanges, propulsion not effective and height low Moderate to major synchronisation errors
4's Deficient	Many major problems (over 6), low height Synchronisation more "off" than "on", mostly major errors

Panel 2 – AS 17.2.2 ARTISTIC IMPRESSION SCORE – 40%

Consider:	
Choreography – the creative skill of composing a routine that combines artistic and technical elements; variety and creativity.	100%
Music Interpretation – expressing the mood of the music; use of the music's structure.	
Manner of Presentation – the manner in which swimmers present the routine to viewers; total command of performance.	

ADDITIONAL FACTORS SPECIFIC TO THE FREE COMBINATION ROUTINE

CHOREOGRAPHY: Variety, creativity, pool coverage, patterns & transitions

- Consider the choreography around the exchanges as a key factor in judging the combination routines.
- Consider the variety of moves. Is there a variety in the exchanges? Are team exchanges done involving different numbers of competitors? Is there variety in the moves used within the exchanges? (i.e. body boosts, figures, highlights-throws, stacks, platforms) Are the exchanges between parts *creative* and *unique* or predictable? Is there an element of surprise?



- Consider the creativity of moves. The stronger athletic performances will show energetic, original, imaginative moves in the parts and exchanges.
- Are the same competitors always used for solo/duet/trio and highlight parts or is there a variety of competitors used in all parts?
- Consider the number & order of parts. Are there too many parts so that the judge does not have time to appreciate what is being done? Are the parts with less than 3 competitors interspersed between team parts OR are there several solo/duet parts in a row?
- Consider the overall flow of the routine. Does the routine flow logically and cover the pool or is it fragmented by the parts with a lack of logical movement? How well are the parts woven together? There should be a harmonious blend of all parts. Each part should seem needed in order to make the routine seem whole. Is the performance seamless with each part and exchange flowing and adding to the overall impression of the routine? Does each part work well together?
- Acrobatics are usually an important part of the FRC highlights. There is not a rule fixing the maximum number of acrobatics as it is now for free team. Consider for acrobatics the variety, their distribution in time and place and if there is a correct balance compared with other type of movements. In other words: does the routine content rely mostly in acrobatics? Do acrobatics disrupt the cohesion and fluency of the routine or on the contrary contribute to build a complete picture of the routine?

MUSIC INTERPRETATION: use of music

- How well do the competitors in each part interpret the music?
- Consider the musical interpretation throughout the exchanges.
- Although a theme is not required, those routines which clearly convey a theme or story will contribute positively to the overall package and will be rewarded by the judges accordingly.
- If there is a theme, do all parts of the routine portray the theme?

MANNER OF PRESENTATION: total command

- Throughout each part of the music, competitors ideally should be showing **TOTAL COMMAND**, compelling the judge to watch.
- In addition to those swimming, the competitors waiting should also give you the feeling that they are involved and part of the routine.



ARTISTIC IMPRESSION: Free Combination Routine EXCHANGES

9's Excellent - Near Perfect	Exchanges surprising, unexpected, "WOW" factor: no distraction during exchange, competitors just 'disappear' when finished and 'appear' to start
8's Very Good	Exchanges very good and interesting, no wait time but more obvious what is happening; some distraction by competitors at actual time of exchange
7's Good	Exchanges good but somewhat predictable, minimal wait time, may stay on 1 side of pool for too long, some distraction by competitors at the actual exchange
6's Competent	Exchanges ordinary and predictable with wait time, competitors finishing a part and those starting a part are distracting
5's Satisfactory	Exchanges satisfactory and simple with a lot of wait time (body boost under to finish part, waiting and surfacing to start next part); swimming in and out of the exchanges is awkward
4's Deficient	Exchanges don't appear to link routine, looks like separate sections with lack of connection

Panel 3 – AS 17.2.3 DIFFICULTY SCORE – 30%

Consider:	
Difficulty – the quality of being hard to achieve. Difficulty of all movements and the difficulty of synchronisation.	100%

ADDITIONAL FACTORS SPECIFIC TO THE FREE COMBINATION ROUTINE

DIFFICULTY: Consider the difficulty of each part and exchange

- Consider the difficulty of each part of the routine. Are there simpler parts?
- Are there resting spots with breaks in energy?
- Consider the number of competitors in the parts. It is more difficult to swim team parts with 10 competitors than with 4. Consider also actions in cadence or done by groups of 4/6, 4/4 or other combinations. Sometimes these actions add difficulty, but can also clearly decrease it. Consider also that it is more difficult to swim team parts than solo parts.



- Are there a variety of competitors used for highlights? The more competitors involved, the more difficult to synchronise but easier to sustain (a platform for ex.). Think on how much do the acrobatics contribute on global difficulty: if the performance of acrobatics take, let's say the 25% of routine time that is 1 minute, the 25% of your score goes for acrobatics? As there is no rule or "official" agreement on this, discuss with the panel the weighting of acrobatics in difficulty score.
- Consider the length of time of each part. Is it long enough to judge true skill level? It is not enough with one boost in the solo part to consider the skill level for example.
- Consider the order of parts. Routines having all the team parts at the beginning with solo and duet parts at the end is less difficult than having team parts spread out and at the end of the routine when competitors are tired. Look for balance in distribution to consider the difficulty.
- Consider the difficulty between exchanges of entering and exiting parts
- Does the new part have little setup time and is it risky?
- Are any of the exchanges blind where the competitors finishing one part can't see the next competitors starting or vice versa? Blind exchanges are more difficult.
- How close are the competitors finishing one part to those starting another part? The closer together the more difficult.
- Are exchanges underwater or at the surface?
- Is there a variety in the type of exchange used?

DIFFICULTY: Free Combination Routine EXCHANGES

9's Excellent – Near Perfect	Almost flawless, minute deviations, risk and difficulty throughout all exchanges, seamless flow between parts
8's Very Good	Most difficult components present and many high risk elements during exchanges, no wait time between parts
7's Good	Difficult, but may be limited by ability , less complex, may have minimal wait time between exchanges, some high risk elements but somewhat predictable
6's Competent	Predictable and ordinary exchanges, medium difficulty with some risk evident in exchanges
5's Satisfactory	Little difficulty or risk in exchanges, lots of time for visual checks, rest spots, easier exchanges
4's Deficient	Minimal difficulty and no risk in exchanges, basic simple moves with long setup times



APPLICABLE RULES

AS 4 SESSIONS

AS 4.4 Combination: Preliminaries/Finals

Free Combination has eight (8) to ten (10) competitors who make a combination of routines. The routines are choreographed to music

AS 6 ENTRIES

AS 6.2.2

For World Championships and FINA competitions, Free Combination routines shall consist of ten (10) competitors.

AS 13 ROUTINE SESSIONS

AS 13.3

A free combination shall consist of eight (8) to ten (10) competitors

AS 13.6.2

If the lack of the reserve reduces the combination size to less than that defined in AS 6.2.2 or AS 13.3 the team shall be disqualified.

AS 14 TIME LIMITS FOR ROUTINES

AS 14.1.5

Combination time limit is 4 minutes 00 seconds.

ASAG 5 The time limits for age groups, including ten (10) seconds of deck movements, shall be:

Age	Combination (minutes)
12 years and under	3.00
13, 14, 15 years	3.30
Juniors: 15-18 years	4.00

AS 14.1.7

There shall be an allowance of fifteen (15) seconds less or plus the allotted time for Combination.

AS 14.1.8

In routine events, the walk-on of the competitors from the designated starting point to achievement of a stationary position(s) may not exceed 30 seconds. Timing shall commence when the first competitor passed the starting point and end when the last competitor becomes stationary.



AS 14.1.9

In routine events, when the Routine starts in the water, the time allowance for the walk-on of the competitors from the designated starting point to the achievement of a starting position in the water shall not exceed 30 seconds. Timing shall commence when the first competitor moves past the starting point and end when the last competitor assumes a starting position.

AS 18 DEDUCTIONS PENALTIES AND OTHER MATTERS IN ROUTINES

A **one (1) point penalty** shall be deducted from the routine score if:

1	AS 18.2.1 The time limit of ten (10) seconds for deck movements is exceeded
2	AS 18.2.2 There is a deviation from the specified routine time limit allowed (less or more than) for the routine and in accordance with AS 14.1
3	AS 18.2.3 If the time limit of 30 seconds for the deck walk-on is exceeded.
4	AS 18.2.5 A competitor has made a deliberate use of the bottom of the pool during the routine.

A **two (2) point penalty** shall be deducted if:

1	AS 18.2.5 A competitor has made a deliberate use of bottom of the pool during a routine to assist another competitor
2	AS 18.2.6 A routine is interrupted by a competitor during the deck movements and a new start is allowed.
3	AS 18.2.7 If during the deck movements in team routines competitors are executing stacks, towers or human pyramids
4	AS 18.4.1 For violations of each general requirement 2,3,4 and required element 1



D. HIGHLIGHT ROUTINE

The Highlight Routine is the newest event in Artistic Swimming and it will be included in the World Championships and World Series programs. It has 8-10 swimmers. The time limit is two minutes and thirty seconds.

There are three required elements in this routine:

1. A minimum of four acrobatic movements
2. A connected or intertwined action
3. A float to give a kaleidoscopic effect.

Required Elements #1 - #3 may be performed in any order.

All members must be involved when performing the required elements. A two (2) point penalty shall be deducted from the routine score for each required element omitted (AS 18.6.1). If one, two, three or four of the acrobatic movements are missing one 2-point penalty will be given because the element has not been performed as prescribed (AS 18.6.2).

In Highlight Routine competition, no penalty shall be deducted if a team has less than 10 swimmers. But, it has to be 10 swimmers for the FINA competitions and World Championships (AS 6.2.2) and to be 8 -10 swimmers for another competitions.

Definitions of the required elements:

Acrobatic movement: is a general term for jumps, throws, lifts, stacks, platforms, etc., which is performed as spectacular gymnastic feats and/or risky actions, and is mostly achieved with assistance by another swimmer(s).

The acrobatic movement ends with complete submersion of all participants including the one(s) being lifted. For multiple acrobatic movements:

When submersion occurs between two acrobatic movements it will be considered as two lifts.

When two acrobatic movements happen simultaneously it will be considered as one lift.

Note: This description of acrobatic movements also applies to Free Routines. and Technical Routines.

Connected or intertwined action: When swimmers join or link together they create a connected action. Intertwined is the act of twisting together and around each other in spirals.

A float to give a kaleidoscopic effect: A float is a formation or pattern swimmers carry out with their bodies at the surface of the water. Some parts of their bodies can be above or below the surface. A kaleidoscopic effect is a symmetrical design or pattern that continuously shifts and rapidly changes pattern or shape.



Judging the Highlight Routine:

The Highlight Routine is judged like a Free Routine by three panels. The panels are:

- First panel – Execution Score – 30%.

This panel will consider:

- Execution – the level of excellence in performing highly specialized skills. Execution of all movements.
 - Synchronisation – the precision of movements in unison, one with the other, and the accompaniment above, at and below the surface. Synchronisation of timing of one with another and with music.
- Second panel - Artistic Impression Score – 40%

This panel will consider:

- Choreography – the creative skill of composing a routine that combines artistic and technical elements. The design and weaving together of variety and creativity of all movements.
 - Music Interpretation – expressing the mood of the music, use of the music's structure.
 - Manner of Presentation – the manner in which the swimmer(s) present(s) the routine to the viewers. The total command of the performance of the routine.
- Third panel – Difficulty Score – 30%
- This panel will consider:
- Difficulty – the quality of being hard to achieve. Difficulty of all movements and of synchronisation.

- **First Panel – Execution**

In this routine the swimmers are performing very specialised acrobatic skills for about 40% of the routine time. To be able to judge acrobatic moves we must observe very closely the following:

- How much time they spend on preparation under the water.
- How high they go (how much air under the athlete who is thrown) and how stable or moving they are.
- If what they aim for is done well.

In acrobatic moves only when swimmers move with precision and in unison can they get the best results.

The principles of analyzing acrobatic moves are the same for jumps, lifts, throws, stacks and platforms.

Follow the example of how a jump can be analysed to be able to score any acrobatic movement.



- Analysis of a jump: The starting position of this movement begins with the preparation under or above the water. This preparation must be smooth; it must be aesthetically pleasing, fast, clear and compact. And this is where the judge must check the synchronisation of the precision of movement in unison.
- Next, comes the jump of the airborne swimmer.
 - As judges, we look at the result of the swimmers working in unison.
 - If they are able to work in unison and use their specialised skills for acrobatics efficiently then the jump of the airborne swimmer will be able to reach its maximum height, 3+ meters.
 - The movement the airborne athlete is making is also evaluated.
 - For example, if her movements are straight, sideways, piked, stable or rotating.
 - Also consider the shape her body makes and the extension of her body in the positions.
 - During the jump the action should be at all times aesthetically pleasing.
- Finally, we evaluate the water entry.
 - It can be head first or feet first. But athlete can also enter the water on their side, front or back. The swimmer should maintain complete body extension until submergence, with minimal splash unless a splash is choreographed.
 - Also, the swimmers' body's extension until they are completely submerged under the water. It is important that the entry makes minimal water splash unless it choreographed with a deliberate splash.
 - The second element is a connected or intertwined action.
 - Competitors can be connected with any body part OR
 - Competitors can be intertwined –closed connected in a way that can't be easily separated.
 - In the execution of these actions we want to see a strong link between the swimmers and that the spacing between the swimmers is symmetrical and the motion or twisting is pleasing to the eye.
 - The execution of the float is also important in the Highlight Routine.
 - In floats some part of their bodies can be above the surface such as arms out, ballet leg, etc. or can be below the surface such as pikes, front layouts, etc.
 - To give a kaleidoscopic effect the swimmers create a pattern that has a symmetrical design and rapidly changes. Each change creates a new float.
 - At least two changes will be required to give a kaleidoscopic effect.
 - The swimmers should lock each float so that its design clearly shows.
 - The space relationship between each swimmer, the angle of each body position and the swimmer's body extension should be evaluated.



- The transitions should be rapid and efficient between the floats.
 - In order for all these elements to happen synchronisation is essential.
 - The rest of the program is judged like the execution of a Free Routine.

- **Second Panel – Artistic Impression**
 - Due to the time limit of two minutes and thirty seconds and the three required elements that take at least one minute thirty seconds, the choreography of this program is very intense.
 - Even the name of the program “Highlight” indicates how demanding it can be because the entire routine should be memorable and not only parts of it.
 - A lot of emphasis must be given to the weaving of the required elements with the rest of the routine to choreograph movement in the routine.
 - Why do we need to spend so much time on movement in the choreography? Well that is because most of the required elements are not moving.
 - Another challenge in the Highlight Routine is that the first requirement that has a minimum of four acrobatic movements involves all the swimmers but you only see one or two swimmers above the surface.
 - To achieve variety the choreography is an important part of the one-minute, using eight, six, fours and twos.
 - To create a memorable routine, music and manner of presentation must have a big impact. A theme or unusual music can make or break the routine.
 - Keeping and using the principles of judging choreography in the free routine, the Highlight Routine can be judged correctly.

- **Third Panel – Difficulty**
 - The third panel of judges will score Difficulty worth 30% of the routine score.
 - Analysis of acrobatic movements:
 - In lifts the base is judged.
 - A single base is easier than a double base.
 - A stable base is easier than a moving base.
 - Small area of and/or unstable bases (eg. Standing on the palm(s), Handstand on the soles) are difficult.
 - Consider what the supported person is doing.
 - A simple leg stand is easier than a handstand.
 - A stable stand is easier than a turning stand and gymnastic movements are more difficult than a stationary position.
 - Multiple position changes on the platform with fast traveling are difficult.



- In jumps, Difficulty is based on the complexity of movements done in the air as well as how high the airborne swimmer goes.
 - In rotations, backwards rotations are easier than forward or sideways rotations.
 - Also during the rotation the body can make a full turn around a horizontal axis.
 - One turn is easier than a double or triple turn.
- Everything else is judged like a Free Routine but as a reminder the composition or the placement of Difficulty in the routine makes a difference.
 - The speed and the pool coverage also adds to the difficulty in the Highlight Routine due to the time limit.
 - In the float and the joined action, failure to connect, particularly if minimal time is given for the connection adds to the Difficulty.
 - Also patterns become more difficult by increasing the number of patterns and types of changes made along with the spatial relationships of swimmers.



E. TECHNICAL ROUTINES

1. SCORING A TECHNICAL ROUTINE

AS 4 SESSIONS

AS 4.2 Technical Routine. : Preliminaries /Finals

In the Technical Routine each Solo, Duet, Mixed Duet and Team must perform the required elements described in the Appendix VI of the FINA Handbook. The required elements are selected by the TASC every four (4) years, subject to approval by the FINA Bureau
The routines are choreographed to music.

AS 14 Time Limits for Technical Routines

AS 14.1. Time limits for Technical Routines including ten (10) seconds for deck movement.

AS 14.1.1 – Technical Routine Solo: 2 minutes 00 seconds

AS 14.1.2.- Technical Routine Duet: 2 minutes 20 seconds

AS 14.1.3 – Technical Routine Mixed Duet: 2 minutes 20 seconds

AS 14.1.4.- Technical Routine team: 2 minutes 50 seconds

*These time limits apply for the Junior age category as well.

AS 17 Judgment of Routines

In routines, the competitor can obtain points from 0 to 10 using one tenth points.

AS 17.3. Technical Routines

- In Technical Routines each judge shall award score (s) from 0 to 10 points (see 17.1)
- Execution Panel shall award one score for Execution of all movements that do not have an assigned degree of difficulty, and Synchronisation of all movements that do not have an assigned degree of difficulty.
- Impression panel judges shall award one score for Difficulty, Choreography, Music Interpretation and Manner of presentation.
- Elements Panel judges shall award individual scores for the Execution and Synchronisation of each required element with an assigned degree of difficulty.
- All of the following arrays are subject to the decision of the TASC.



- **AS 17.3.1 First panel – EXECUTION Score – 30%**

Consider	Solo	Duet	Team
<p>EXECUTION – the level of excellence in performing highly specialised skills. Execution of all movements that do not have an assigned degree of difficulty.</p>	90%	50%	50%
<p>SYNCHRONISATION - Synchronisation of all movements that do not have an assigned degree of difficulty. The precision of movements in unison, one with the other, and the accompaniment above, at and below the surface. Synchronisation of timing of one with another and with music.</p>	10%	50%	50%

- **AS 17.3.2 Second panel - IMPRESSION Score - 30%**

Consider	Solo	Duet	Team
<p>DIFFICULTY – the quality of being hard to achieve. Difficulty of all movements that do not have an assigned degree of difficulty and of synchronisation.</p>	50%	50%	50%
<p>CHOREOGRAPHY - the creative skill of composing a routine that combines artistic and technical elements. The design and weaving together of variety and creativity of all movements.</p>			
<p>MUSIC INTERPRETATION - expressing the mood of the music, use of the music's structure.</p>	50%	50%	50%
<p>MANNER OF PRESENTATION - the manner in which the swimmer(s) present(s) the routine to the viewers. The total command of the performance of the routine.</p>			



AS 17.3.3 Third panel – ELEMENTS Score - 40%

Consider

EXECUTION – the level of excellence in performing highly specialised skills. Execution of each required element with an assigned degree of difficulty.

SYNCHRONISATION – Synchronisation of each required element with an assigned degree of difficulty. The precision of movements in unison, one with the other, and the accompaniment above, at and below the surface. Synchronisation of timing of one with another and with music.

Consider:	Solo	Duet, Mixed Duet, Team
EXECUTION	90%	50%
SYNCHRONISATION	10%	50%

AS 17.4 In the Technical Routine, if one or more judges on the Element Panel has entered a zero for a missing element or portion of an element, the referee will review the official video. If the required element has been executed, then the average of the awards of the other remaining judges shall be computed and shall be considered as the missing award(s). This shall be calculated to the nearest 0.1 point.

If the required element has not been performed correctly, the referee shall instruct the scorer to record zeros for that element for each judge.

AS 18 Deductions Penalties and other Matters in Routines

AS 18.1 In **Team** competition, whether in Free Routine Preliminary, Free Routine Final or **Technical Routine**, **one half point** penalty shall be deducted from the total score **for each member less than eight (8)** (see AS 13.2).

AS 18.2 If one (or more) competitor(s) stops swimming before the routine is completed the routine will be disqualified. If the cessation is caused by circumstances beyond the control of the competitor(s), the Referee shall allow the routine to be re-swum during the session.



A **one (1) point penalty** shall be deducted from the routine score if:

1	AS 18.2.1 The time limit of ten (10) seconds for deck movements is exceeded
2	AS 18.2.2 There is a deviation from the specified routine time limit allowed (less or more than) for the routine and in accordance with AS 14.1 and ASAG 6.
3	AS 18.2.3 If the time limit of 30 seconds for the deck walk-on is exceeded.
4	AS 18.2.5 A competitor has made a deliberate use of the bottom of the pool during the routine.

A **two (2) point penalty** shall be deducted if:

1	AS 18.2.5 A competitor has made a deliberate use of bottom of the pool during a routine to assist another competitor.
2	AS 18.2.6 A routine is interrupted by a competitor during the deck movements and a new start is allowed.
3	AS 18.2.7 If during the deck movements in team routines competitors are executing stacks, towers or human pyramids.

Penalties and other Matters in Technical Routines

AS 18.4.1 In a Technical Routine, if one or more swimmers omit all or part of an element, or perform an incorrect action in an element, the judges on the Element Panel shall award a zero score for that particular element.

AS 18.4.2 In a Technical Routine, any change in the order of elements results in a zero score from the judges for the element not placed in the correct order.

Example:

Element #1→#2→#4→#3→#5 (Incorrect order)

The judges on the Element Panel shall award a zero for #3.

AS 18.4.3 If one or more judges enter a score for the incorrect element, a referee should check an official video and make sure it was incorrect, and the referee can change the judge's score to 0.

AS 18.4.4 If a judge enters zero (0) to a correct element, a referee should follow according to SS 17.4.



AS 18.4.5 A half-point (0,5) penalty shall be deducted from the Execution score for violations of Duet required elements 6 and 7, Mixed Duet required elements 6,7 and 8 and Team required elements 6, 7, 8 and 9 of the Appendix VI.

AS 18.4.6 In Solos and Duets, a half-point (0,5) penalty shall be deducted from the Elements score if an element was not performed parallel to the sides of the pool where the panel of judges have been placed.



2. REQUIRED ELEMENTS

GENERAL REQUIREMENTS

1. In World Junior Championships, Required Elements for Junior Categories are used.
2. Unless otherwise specified in the description of an element:
 - All figures or components thereof shall be executed according to the requirements described in appendices II-IV.
 - All elements shall be executed high and controlled, in uniform motion with each section clearly defined.
 - When a mistake occurs in required elements including a continuous spin, AS11.2 will be applied.
3. Required Elements #1 - #5 shall be judged within the Elements score.
4. Required Elements #1 - #5 are to be performed in the order listed.
 - It is strongly recommended, for clarity of judgment that Required Elements #1 - #5 are separated by other content.
5. For Solo, Duet, Mixed Duet only, Required Elements #1 - #5 shall be performed parallel to the sides of the pool where the panels of judges are seated.
6. Time limits as in AS 14.1.





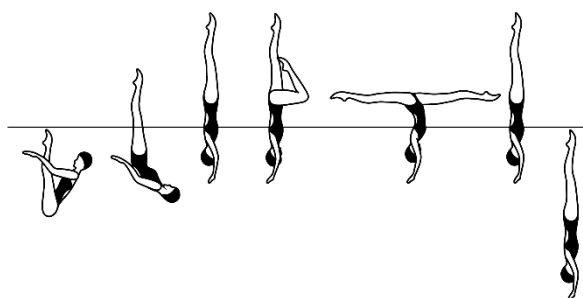

Clarification Note: The Technical Elements performed in Technical Routines will follow the same Twist/Spin penalties as applied in figures.

SENIOR SOLO REQUIRED ELEMENTS

(DD 14,3)

1. Starting in a **Submerged Back Pike Position** with the legs perpendicular to the surface, a *Thrust* is executed to a **Vertical Position** and with no loss of height one leg is lowered rapidly to a **Bent Knee Position** and as the vertical leg is lowered forward, the bent knee is extended to assume an **Airborne Split Position** and maintaining maximum height the legs are lifted symmetrically to a **Vertical Position**, followed by a *Vertical Descent*. All movements are executed rapidly. [DD 2.7]









							Total
NVT=		31.0	52.0	-	-	15.0	98
PV =		3.16	5.31	-	-	1.53	

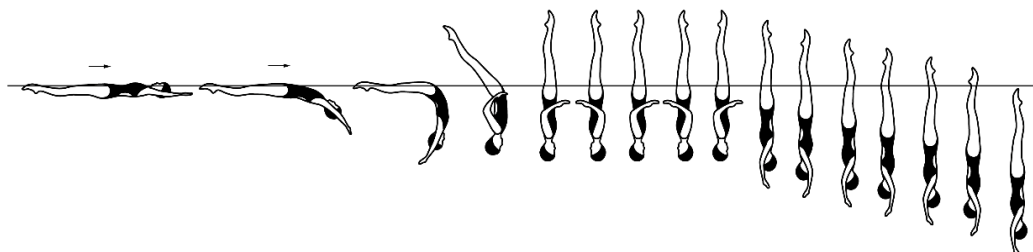

SENIOR SOLO REQUIRED ELEMENTS-cont'd

2. A *Dolphin* is initiated, and the back continues to arch to assume a **Surface Arch Position**. The legs are lifted to a **Vertical Position**. Two *Full Twists* (720°) are executed, and continuing in the same direction a *Continuous Spin 1080°* (3 rotations) executed. [DD 3.4]









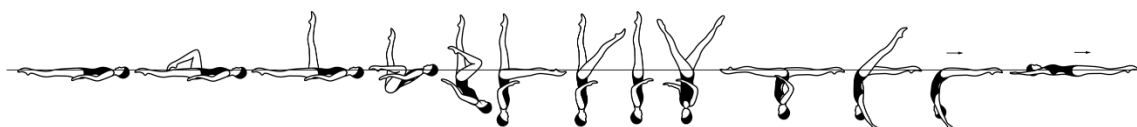

						Total
NVT=		12.0	37.0	54.0	35.0	138
PV =		0.87	2.68	3.91	2.54	

3. 141 - Stingray

A *Flamingo* is executed to a **Surface Flamingo Position**, travelling head first. With the ballet leg maintaining its vertical position, the hips are lifted as the trunk unrolls while the bent leg moves with the knee at the surface to assume a **Fishtail Position**. The horizontal leg is lifted in an arc over the surface. As it passes the vertical leg which moves symmetrically, a 180° rotation is started and is completed as a **Split Position** is assumed. A *Walkout Front* is executed. [DD 3.2]









										Total
NV=	10.5	11.0	13.0	22.5	20.5	20.0	23.0	8.0	128.5	
PV=	0.82	0.86	1.01	1.75	1.60	1.56	1.79	0.62		

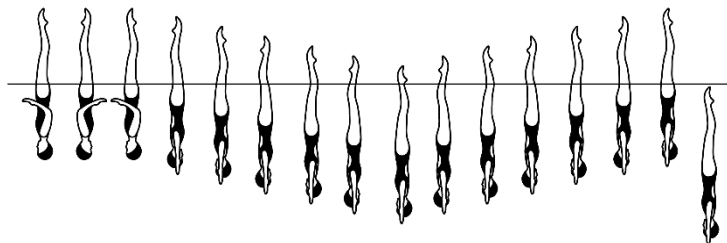

SENIOR SOLO REQUIRED ELEMENTS-cont'd



4. Starting in a **Vertical Position** a *Full Twist* is executed followed by a *Combined Spin of 1080°* (3 rotations + 3 rotations). [DD 2.7]

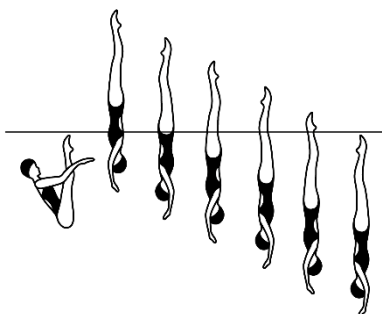

					Total
NVT=	32.0	54.0	-	14.0	100
PV =	3.20	5.40		1.40	

5. Starting in a submerged **Back Pike Position** with the legs perpendicular to the surface, a *Barracuda Continuous Spin 720°* (2 rotations) is executed. [DD 2.3]



			Total
NVT=	31.0	50.0	81
PV =	3.83	6.17	





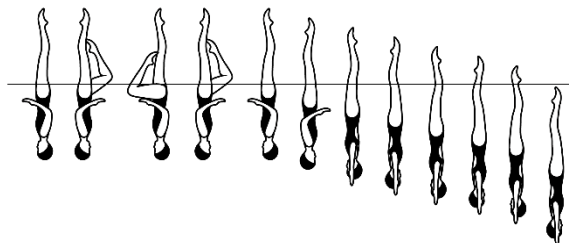

SENIOR DUET REQUIRED ELEMENTS

(DD 13,5)







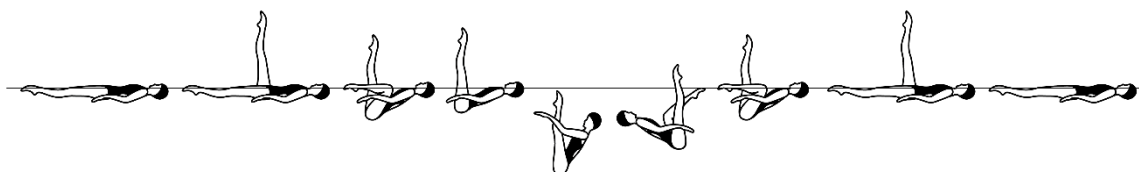

- Starting in a **Vertical Position**, a *Full Twist* is executed as one leg is lowered to a **Bent Knee Vertical Position**. Continuing in the same direction another *Full Twist* is executed, as the bent knee is extended to a **Vertical Position**. A *Continuous Spin of 1080°* is executed. (3 rotations). [DD 2.3]



				Total
NVT=	20.5	22.0	35.0	77.5
PV =	2.65	2.84	4.52	

- From a **Back Layout Position** a straight leg is lifted to a **Ballet Leg Position**. The shin of the horizontal leg is drawn along the surface to assume a **Surface Flamingo Position**. The bent knee is straightened to a **Surface Ballet Leg Double Position**. Maintaining the legs vertical, the body submerges to a **Submerged Back Pike Position** until the feet are just below the surface. Executing a 360° rotation the body rises to the surface simultaneously lowering one leg with foot at the surface to assume a **Surface Flamingo Position**. The horizontal leg is straightened horizontally to a **Ballet Leg Position**. The vertical leg is lowered straight to a **Back Layout Position**. Head first travel is allowed during the Ballet Leg sequence. [DD 2.9]





								Total
NVT=	18.5	13.0	13.0	15.0	18.5	13.0	18.5	109.5
PV =	1.69	1.19	1.19	1.37	1.69	1.19	1.69	



SENIOR DUET REQUIRED ELEMENTS-cont'd

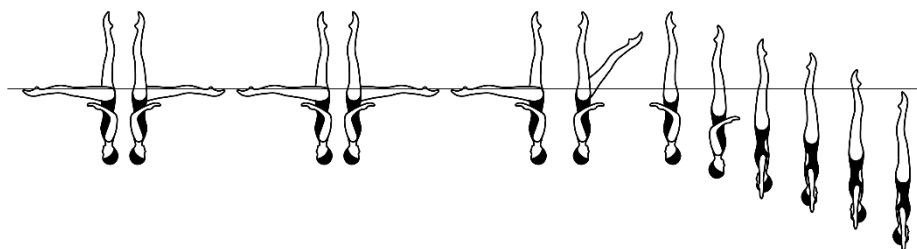

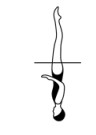

3. Starting and maintaining a **Fishtail Position**, with the horizontal leg leading toward the vertical leg, 2 rapid rotations (720°) are executed. Continuing in the same direction and same speed, a rapid *Full Twist* is executed as the horizontal leg is lifted to a **Vertical Position**. A *Continuous Spin* 720° is executed. [DD 2.8]

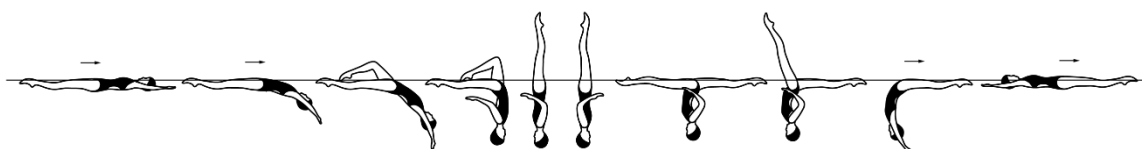

				Total
NVT=	50.0	26.5	31.0	107.5
PV =	4.65	2.47	2.88	

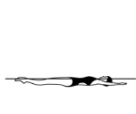
4. A Cyclone is executed to the **Vertical Position**. A *Half Twist* is executed. Continuing in the same direction an additional rotation of 180° is executed as the legs are symmetrically opened to assume a **Split Position**. A *Walkout Front* is executed. [DD 3.0]

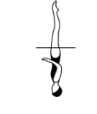
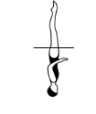

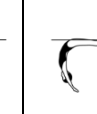





							Total
NVT=	17.5	29.0	21.0	20.0	23.0	8.0	118.5
PV =	1.48	2.45	1.77	1.69	1.94	0.68	

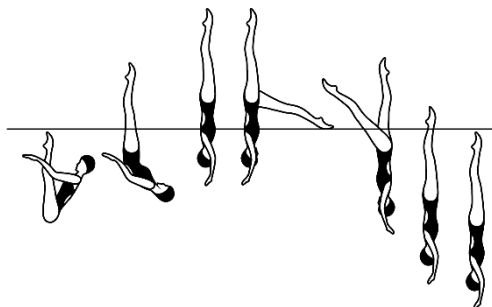

SENIOR DUET REQUIRED ELEMENTS-cont'd

5. Starting in a submerged **Back Pike Position** with the legs perpendicular to the surface, a *Thrust* is executed to a **Vertical Position** and with no loss of height one leg is rapidly lowered to a **Fishtail Position**. The horizontal leg is lifted to a **Vertical Position** as a *Spin 360°* is executed. [DD 2.5]



						Total
NVT=		31.0	34.0	25.5	-	90.5
PV =		3.43	3.76	2.82	-	

6. The routine must contain a lift, jump or throw, this can be placed anywhere in the routine.
7. With the exception of the deck work, entry and the lift, jump or throw, all elements required and supplementary must be performed simultaneously and facing the same direction. Mirror actions are not permitted.





SENIOR MIXED DUET REQUIRED ELEMENTS

(DD 10.9)

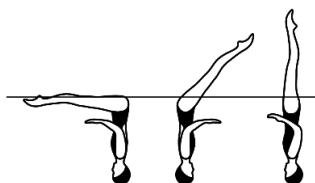



1. From **Front Pike Position** the legs are lifted to **Vertical Position** as a rotation of 360° is executed. [DD 1.5]



		Total
		
NVT=	35.0	35
PV =	10.0	

2. Ballet leg Sequence: A *Ballet Leg* is assumed followed by a rapid exchange to assume the *opposite Ballet Leg* as the vertical leg is lowered straight to horizontal. The horizontal leg is bent to assume a **Surface Flamingo Position**. The bent leg is straightened to a **Ballet Leg Double Position**. Maintaining the **Ballet Leg Double Position**, a rotation of 360° is executed. Travelling head first until the **Ballet Leg Double Position** is assumed. [DD 2.5]



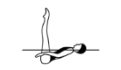
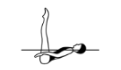



							Total
							
NVT=	10.5	11.0	17.0	13.0	13.0	24.0	88.5
PV =	1.19	1.24	1.92	1.47	1.47	2.71	

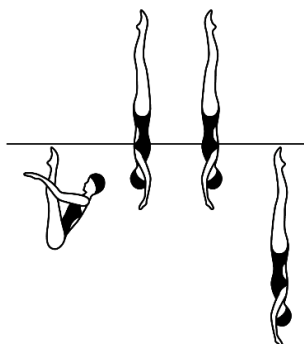

SENIOR MIXED DUET REQUIRED ELEMENTS-cont'd





3. From a **Submerged Back Pike Position** with the legs perpendicular to the surface, a Barracuda Twirl is executed. [DD 2.4]

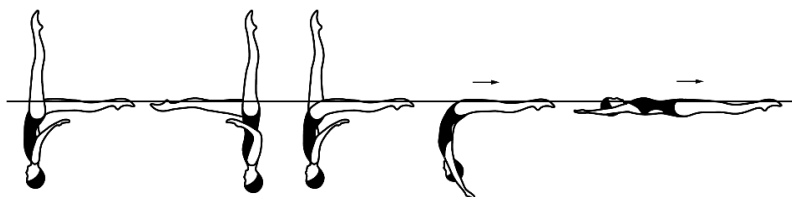

					Total
NVT=	31.0	36.0	15.0	82	
PV =	3.78	4.39	1.83		

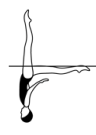
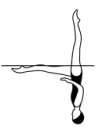
4. From a **Knight Position**, maintaining the vertical alignment of the body, the horizontal leg is moved in a 180° arc at the surface of the water to assume a **Fishtail Position**. Maintaining the angle between the legs, the horizontal leg moves to vertical as the vertical leg simultaneously continues its arc to the surface to assume a **Knight Position**. The vertical leg is lowered to assume a **Surface Arch Position**, with continuous motion a surface *arch to back layout finish action* is executed. [DD 2.2]









						Total
NVT=	18.0	31.0	18.5	8.0	75.5	
PV =	2.38	4.11	2.45	1.06		

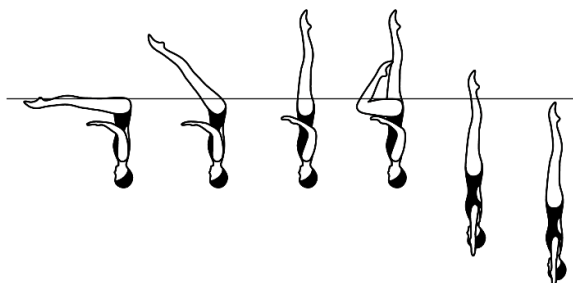

SENIOR MIXED DUET REQUIRED ELEMENTS-cont'd

5. From a **Front Pike Position** the legs are lifted to a **Vertical Position** -A *Full Twist* is executed as one leg is lowered to a **Bent Knee Vertical Position**, followed by a *Continuous Spin of 720° (2 rotations)* as the bent knee is joined to a **Vertical Position**. [DD 2.3]



					Total
NVT=	33.0	20.5	27.0	-	80.5
PV =	4.10	2.55	3.35	-	

6. The routine must contain only one lift, jump, or throw, which can be placed anywhere in the routine.
7. The routine must contain at least one connected action, which can be placed anywhere in the routine. Connected Action: the swimmers must be touching in some manner during the performance of the element.
8. Required Elements #1 - #5 must be performed simultaneously and facing the same direction.





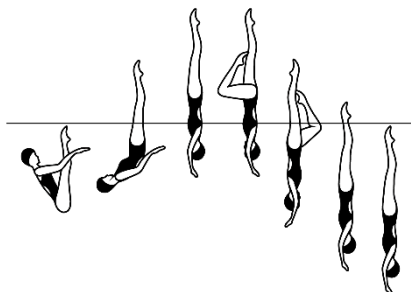

SENIOR TEAM REQUIRED ELEMENTS

(DD 12.9)



- Starting in a **Submerged Back Pike Position** with the legs perpendicular to the surface, a *Thrust* is executed to a **Vertical Position** and with no loss of height one leg is lowered to a **Bent Knee Vertical Position**. A rapid **360° Spin** is executed as the bent knee is extended to a **Vertical Position**. [DD 2.5]

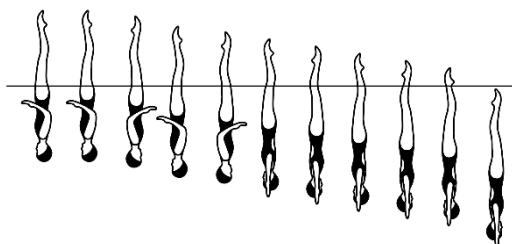

						Total
NVT		31.0	32.0	24.0	-	87
PV		3.56	3.68	2.76	-	

- From **Vertical Position**, a *Full Twist* is executed, followed by a *Continuous Spin* 1440° (4 rotations). [DD 2.2]









				
NVT		32.0	39.0	71
PV		4.51	5.49	

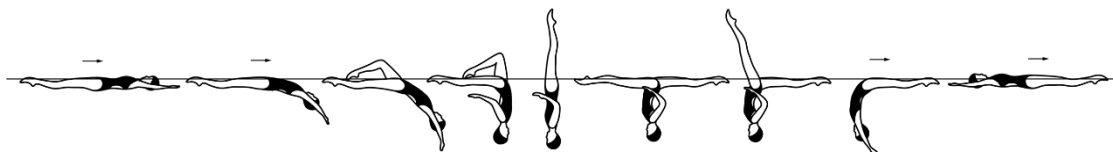

SENIOR TEAM REQUIRED ELEMENTS – cont'd







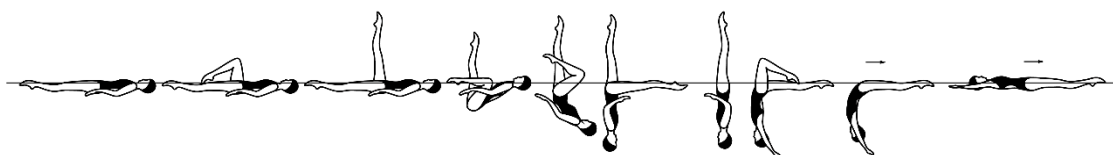

3. A Cyclone is executed to a **Vertical Position**, the legs are symmetrically lowered to a **Split Position**. A *Walkout Front* is executed. [DD 2.6]



							Total
NVT		17.5	29.0	17.0	23.0	8.0	94.5
PV		1.85	3.07	1.80	2.43	0.85	

4. Manta Ray Hybrid: A Flamingo is executed to a **Surface Flamingo Position**, travelling head first. With the ballet leg maintaining its vertical position, the hips are lifted as the trunk unrolls while the bent leg moves with the knee at the surface to assume a **Fishtail Position**. The horizontal leg is lifted rapidly to a **Vertical Position**, as the body rotates 180°. The direction of the 180° rotation is closing into the vertical leg. (Note: A right flamingo start requires the right shoulder back during the 180° rotation and a left flamingo start requires the left shoulder back during the 180° rotation). The legs are lowered rapidly simultaneously to a **Bent Knee Surface Arch Position**. (Note: The **Bent Knee Surface Arch Position** can be assumed by using either leg). The bent knee is straightened to a **Surface Arch Position** and with continuous motion, an *Arch to Back Layout Finish Action* is executed. [DD 3.1]







										Total
NV=	10.5	11.0	13.0	22.5	21.5	21.0	14.5	8.0	122	
PV=	0.86	0.90	1.07	1.84	1.76	1.72	1.19	0.66		

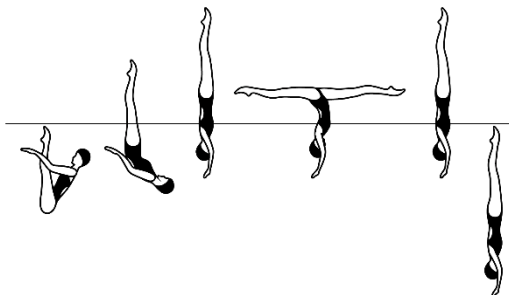

SENIOR TEAM REQUIRED ELEMENTS – cont'd

5. From a **Submerged Back Pike Position**, with the legs perpendicular to the surface, a Barracuda Airborne Split is executed. [DD 2.5]

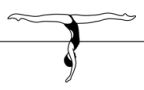

						Total
NV=		31.0	43.0	-	15.0	89
PV=		3.48	4.83	-	1.69	

6. The routine must contain only two acrobatic movements: one using all team members, and one where the swimmers are divided into two subgroups and who perform identical simultaneous acrobatic movements. These may be placed anywhere in the routine. Acrobatic movements: A general term for jumps, throws, lifts, stacks, platforms, etc., which are performed as spectacular gymnastic feats and/or risky actions, and are mostly achieved with assistance from other swimmer(s).
7. The routine must contain a Cadence Action with either arms, legs or both. This may be placed anywhere in the routine. Cadence Action: Identical movement(s) performed sequentially, one by one, by all team members. When more than one cadence action is performed, they must be consecutive and not separated by other optional or required elements. A second cadence action may begin before the first cadence action is completed by all team members but each team member must do the action of each cadence.
8. At least one circle and at least one straight line must be included in the routine.
9. With exception of the deck work, entry, the Acrobatic movements and the Cadence Action, all elements – required and supplementary – must be performed simultaneously and facing the same direction by all team members. Variations in propulsion and direction facing are permitted only during underwater pattern changes and underwater actions and making and finishing a circle. Mirror actions are not permitted with the exception of the circle.





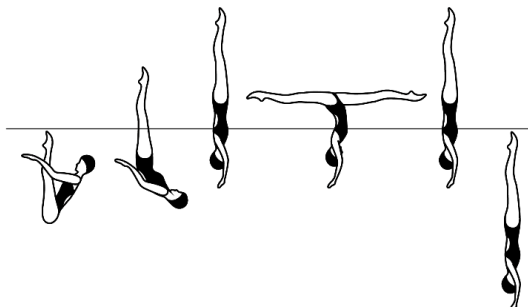

JUNIOR SOLO REQUIRED ELEMENTS

(DD 12.1)



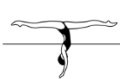

- Starting in a **Submerged Back Pike Position** with the legs perpendicular to the surface, a Barracuda Airborne Split is executed. [DD 2.5]

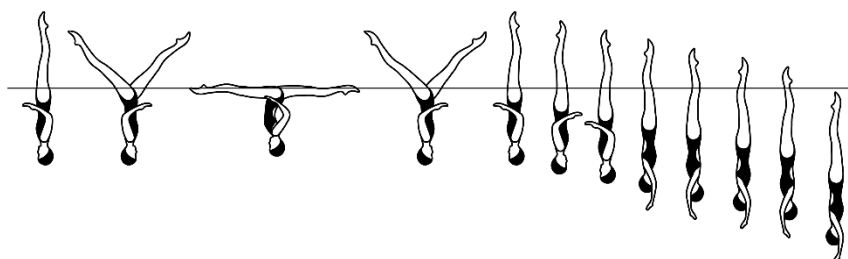

					Total
NVT=	31.0	43.0	-	15.0	89
PV =	3.48	4.83	-	1.69	

- Starting in a **Vertical Position**, the body rotates 360° as the legs are lowered symmetrically to assume a **Split Position**. Continuing in the same direction an additional rotation of 360° is completed as the legs are raised symmetrically to assume a **Vertical Position**. Followed by a *Continuous Spin 1080° (3)* in the same direction. [DD 2.5]



					Total
NVT=	26.0	27.0	35.0	88	
PV =	2.95	3.07	3.98		









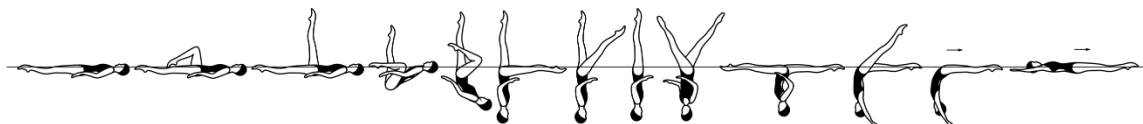

JUNIOR SOLO REQUIRED ELEMENTS-cont'd

3. 141 - Stingray





A Flamingo is executed to a **Surface Flamingo Position**, travelling head first. With the ballet leg maintaining its vertical position, the hips are lifted as the trunk unrolls while the bent leg moves with the knee at the surface to assume a **Fishtail Position**. The horizontal leg is lifted in an arc over the surface. As it passes the vertical leg which moves symmetrically, a 180° rotation is started and is completed as a **Split Position** is assumed. A *Walkout Front* is executed. [DD 3.2]

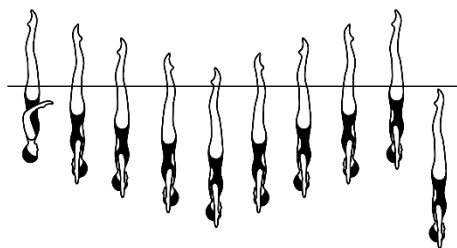

										Total
NV=	10.5	11.0	13.0	22.5	20.5	20.0	23.0	8.0	128.5	
PV=	0.82	0.86	1.01	1.75	1.60	1.56	1.79	0.62		

4. Starting in a **Vertical Position** a *Combined Spin of 720°* (2 rotations + 2 rotations) is executed. [DD 1.9]





					Total
NVT=	42.0	-	14.0	56	
PV =	7.5	-	2.5		

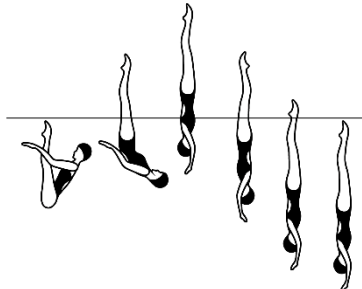

JUNIOR SOLO REQUIRED ELEMENTS-cont'd

5. Starting in a **Submerged Back Pike Position** with the legs perpendicular to the surface, a Barracuda Spin 360° is executed. [DD 2.0]

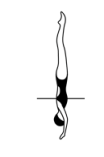
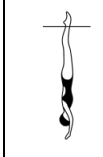
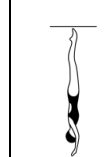

					Total
NVT=	31.0	30.0	-	-	61
PV =	5.08	4.92	-	-	





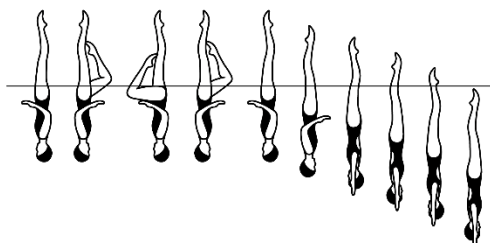

JUNIOR DUET REQUIRED ELEMENTS

(DD 12,4)







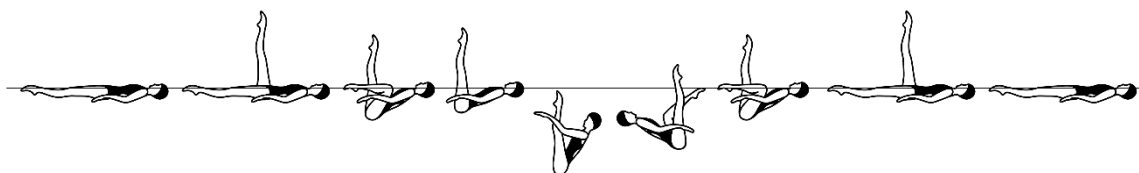

- 1 Starting in a **Vertical Position**, a *Full Twist* is executed as one leg is lowered to a **Bent Knee Vertical Position**. Continuing in the same direction an additional *Full Twist* is completed, as the bent knee is extended to a **Vertical Position**. Followed by a *Continuous Spin of 720°* (2 rotations) is executed. [DD 2.2]



				Total
NVT=	20.5	22.0	31.0	73.5
PV =	2.79	2.99	4.22	

- 2 From a **Back Layout Position** a straight leg is lifted to a **Ballet Leg Position**. The shin of the horizontal leg is drawn along the surface to assume a **Surface Flamingo Position**. The bent knee is straightened to a **Surface Ballet Leg Double Position**. Maintaining the legs vertical, the body submerges to a **Submerged Back Pike Position** until the feet are just below the surface. Executing a 360° rotation the body rises to the surface simultaneously lowering one leg with foot at the surface to assume a **Surface Flamingo Position**. The horizontal leg is straightened horizontally to a **Ballet Leg Position**. The vertical leg is lowered straight to a **Back Layout Position**. Head first travel is allowed during the Ballet Leg sequence. [DD 2.9]



								Total
NVT=	18.5	13.0	13.0	15.0	18.5	13.0	18.5	109.5
PV =	1.69	1.19	1.19	1.37	1.69	1.19	1.69	



JUNIOR DUET REQUIRED ELEMENTS – cont'd



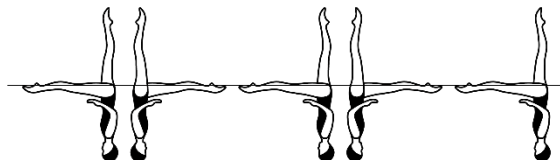

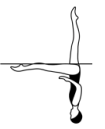
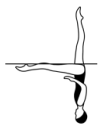

- 3 Starting and maintaining a **Fishtail Position**, with the horizontal leg leading toward the vertical leg, 2 rapid rotations (720°) are executed. [DD 1.8]

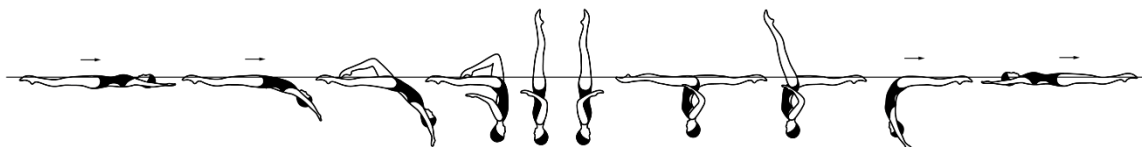

		Total
NVT=	50.0	50.0
PV =	10.0	

- 4 A Cyclone is executed to a **Vertical Position**. A *Half Twist* is executed. Continuing in the same direction an additional rotation of 180° is executed as the legs are symmetrically opened to assume a **Split Position**. A *Walkout Front* is executed. [DD 3.0]









							Total
NVT=	17.5	29.0	21.0	20.0	23.0	8.0	118.5
PV =	1.48	2.45	1.77	1.69	1.94	0.68	

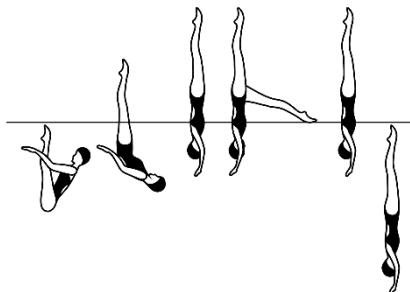

JUNIOR DUET REQUIRED ELEMENTS-cont'd

- 5 Starting in a submerged **Back Pike Position** with the legs perpendicular to the surface, a Flying Fish is executed. [DD 2.5]



						Total
NVT=	31.0	44.0	-	15.0	90.0	
PV =	3.44	4.89	-	1.67		

- 6 The routine must contain a lift, jump or throw, this can be placed anywhere in the routine.
- 7 With the exception of the deck work, entry and the lift, jump or throw, all elements required and supplementary must be performed simultaneously and facing the same direction. Mirror actions are not permitted.





JUNIOR MIXED DUET REQUIRED ELEMENTS

(DD 10.9)

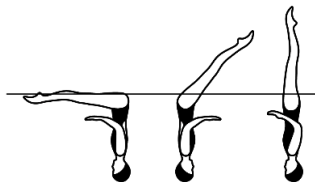





- 1 From **Front Pike Position** the legs are lifted to **Vertical Position** as a rotation of 360° is executed. [DD 1.5]



		Total
		
NVT=	35.0	35
PV =	10.0	

- 2 Ballet leg Sequence: A *Ballet Leg* is assumed followed by a rapid exchange to assume the opposite *Ballet Leg* as the vertical leg is lowered straight to horizontal. The horizontal leg is bent to assume a **Surface Flamingo Position**. The bent leg is straightened to a **Ballet Leg Double Position**. Maintaining the **Ballet Leg Double Position**, a rotation of 360° is executed. Travelling head first until the **Ballet Leg Double Position** is assumed. [DD 2.5]







							Total
							
NVT=	10.5	11.0	17.0	13.0	13.0	24.0	88.5
PV =	1.19	1.24	1.92	1.47	1.47	2.71	

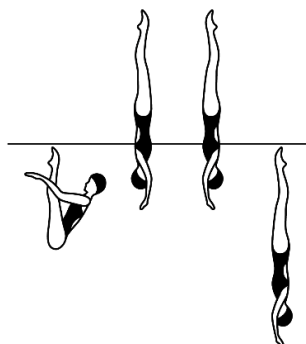

JUNIOR MIXED DUET REQUIRED ELEMENTS-cont'd



- 3 From a **Submerged Back Pike Position** with the legs perpendicular to the surface, a Barracuda Twirl is executed. [DD 2.4]

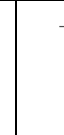

					Total
NVT=	31.0	36.0	15.0	82	
PV =	3.78	4.39	1.83		

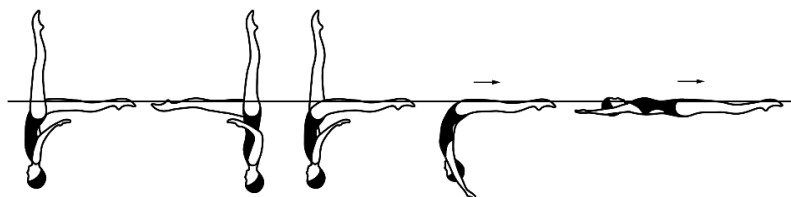
- 4 From a **Knight Position**, maintaining the vertical alignment of the body, the horizontal leg is moved in a 180° arc at the surface of the water to assume a **Fishtail Position**. Maintaining the angle between the legs, the horizontal leg moves to vertical as the vertical leg simultaneously continues its arc to the surface to assume a **Knight Position**. The vertical leg is lowered to assume a **Surface Arch Position**, with continuous motion a surface *arch to back layout finish action* is executed. [DD 2.2]

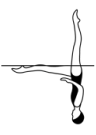







					Total
NVT=	18.0	31.0	18.5	8.0	75.5
PV =	2.38	4.11	2.45	1.06	

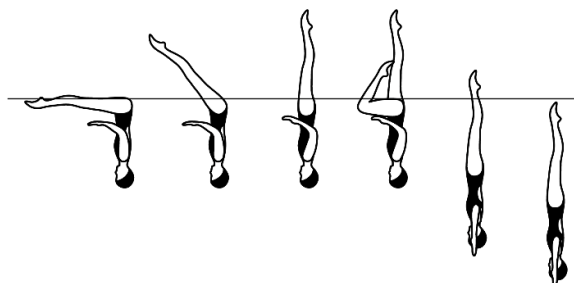

JUNIOR MIXED DUET REQUIRED ELEMENTS-cont'd

- 5 From a **Front Pike Position** the legs are lifted to a **Vertical Position** -A *Full Twist* is executed as one leg is lowered to a **Bent Knee Vertical Position**, followed by a *Continuous Spin of 720° (2 rotations)* as the bent knee is joined to a **Vertical Position**. [DD 2.3]



						Total
NVT=		33.0	20.5	24.0	-	77.5
PV =		4.26	2.65	3.10	-	

- 6 The routine must contain only one lift, jump, or throw, which can be placed anywhere in the routine.
- 7 The routine must contain at least one connected action, which can be placed anywhere in the routine. Connected Action: the swimmers must be touching in some manner during the performance of the element.
- 8 Required Elements #1 - #5 must be performed simultaneously and facing the same direction.





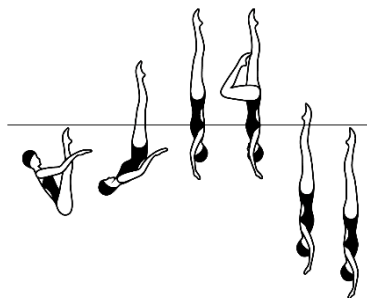

JUNIOR TEAM REQUIRED ELEMENTS

(DD 12.3)



- 1 Starting in a **Submerged Back Pike Position** with the legs perpendicular to the surface, a *Thrust* is executed to a **Vertical Position** and with no loss of height one leg is lowered to a **Bent Knee Vertical Position**. A rapid *180° Spin* is executed as the bent knee is extended to a **Vertical Position**. All movements are executed rapidly. [DD 2.3]

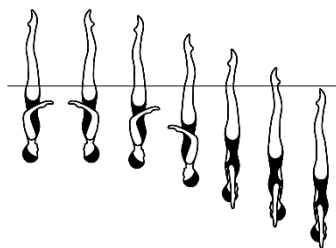

					Total
NVT		31.0	32.0	18.0	81
PV		3.83	3.95	2.22	

- 2 From a **Vertical position**, a *Twist Spin* is executed. [DD 1.8]









				Total
NVT		21.0	31.0	52
PV		4.04	5.96	

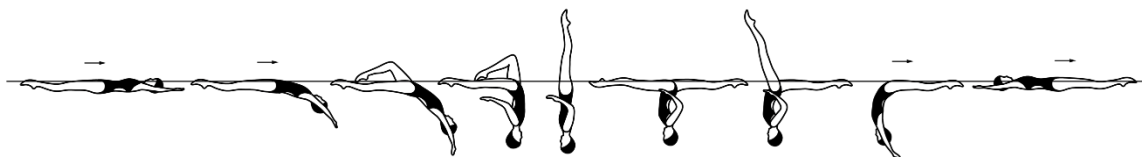

JUNIOR TEAM REQUIRED ELEMENTS-cont'd







- 3 A Cyclone is executed to a **Vertical Position**, the legs are symmetrically lowered to a **Split Position**. A *Walkout Front* is executed. [DD 2.6]

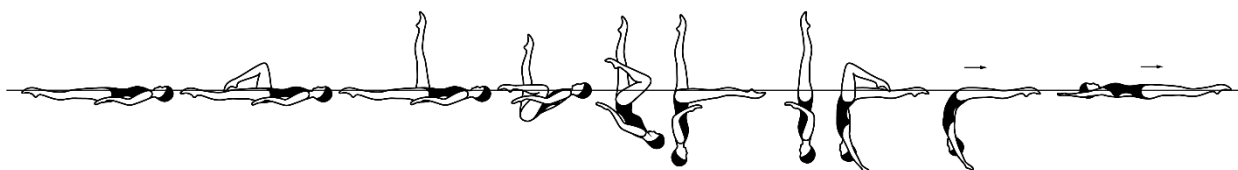

						Total	
NVT		17.5	29.0	17.0	23.0	8.0	94.5
PV		1.85	3.07	1.80	2.43	0.85	

- 4 Manta Ray Hybrid: A Flamingo is executed to a **Surface Flamingo Position**, travelling head first. With the ballet leg maintaining its vertical position, the hips are lifted as the trunk unrolls while the bent leg moves with the knee at the surface to assume a **Fishtail Position**. The horizontal leg is lifted rapidly to a **Vertical Position**, as the body rotates 180°. The direction of the 180° rotation is closing into the vertical leg. (Note: A right flamingo start requires the right shoulder back during the 180° rotation and a left flamingo start requires the left shoulder back during the 180° rotation). The legs are lowered rapidly simultaneously to a **Bent Knee Surface Arch Position**. (Note: The **Bent Knee Surface Arch Position** can be assumed by using either leg). The bent knee is straightened to a **Surface Arch Position** and with continuous motion, an *Arch to Back Layout Finish Action* is executed. [DD 3.1]





								Total	
NV=	10.5	11.0	13.0	22.5	21.5	21.0	14.5	8.0	122
PV=	0.86	0.90	1.07	1.84	1.76	1.72	1.19	0.66	

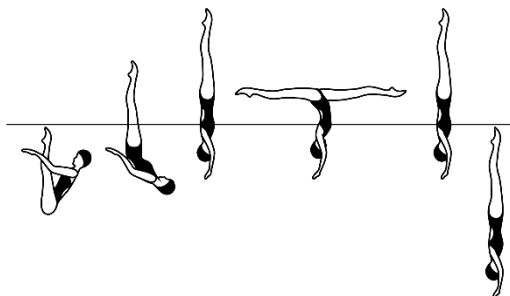

JUNIOR TEAM REQUIRED ELEMENTS-cont'd

- 5 From a **Submerged Back Pike Position**, with the legs perpendicular to the surface, a Barracuda Airborne Split is executed. [DD 2.5]

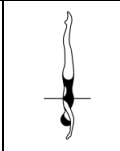
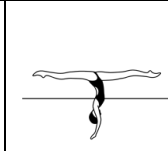
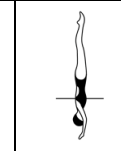
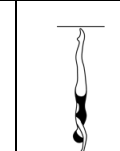

						Total
NV=	31.0	43.0	-	15.0	89	
PV=	3.48	4.83	-	1.69		

- 6 The routine must contain only two acrobatic movements: one using all team members, and one where the swimmers are divided into two subgroups and who perform identical simultaneous acrobatic movements. These may be placed anywhere in the routine. Acrobatic movements: A general term for jumps, throws, lifts, stacks, platforms, etc., which are performed as spectacular gymnastic feats and/or risky actions, and are mostly achieved with assistance from other swimmer(s).
- 7 The routine must contain a Cadence Action with either arms, legs or both. This may be placed anywhere in the routine. Cadence Action: Identical movement(s) performed sequentially, one by one, by all team members. When more than one cadence action is performed, they must be consecutive and not separated by other optional or required elements. A second cadence action may begin before the first cadence action is completed by all team members but each team member must do the action of each cadence.
- 8 At least one circle and at least one straight line must be included in the routine.
- 9 With exception of the deck work, entry, the Acrobatic movements and the Cadence Action, all elements – required and supplementary – must be performed simultaneously and facing the same direction by all team members. Variations in propulsion and direction facing are permitted only during underwater pattern changes and underwater actions and making and finishing a circle. Mirror actions are not permitted with the exception of the circle.



F. MIXED DUET

The Mixed Duet is a unique event with a male and a female athlete demonstrating their technical synchro skills in a special artistic relationship. The judging format and scoring criteria are the same as in traditional duets but there are additional demands and opportunities in both Technical and Free Mixed Duets that challenge the choreographer and the athletes to achieve a high level of creativity and expertise.

1. TECHNICAL MIXED DUETS

The Technical mixed duet has 5 elements that are judged by the Element Panel.

Note: Mirror actions are permitted

Relevant penalties:

AS 18.4.5 A half point (0.5) penalty shall be deducted from the Execution score for violations of Duet required elements 6 and 7, Mixed Duet required elements 6,7 and 8 and Team required elements 6,7,8 and 9 of the Appendix VI.

AS 18.4.6 In Solos, Duets and Mixed Duets, a half point (0.5) penalty shall be deducted from the Elements score if an element was not performed parallel to the sides of the pool where the panel of judges have been placed.

In the Technical Mixed Duet, attention must be focused on the execution of the required elements which is judged by the Elements Panel while the lift, jump or throw and the connected action are evaluated by the Execution Panel.

Synchronisation of the elements will be judged by the Elements panel while synchronisation of all other movements will be assessed by the Execution Panel.

The Impression Panel will assess Difficulty, Choreography, Use and Interpretation of the Music and Manner of Presentation. Added difficulty can enhance this score. Creativity in design of hybrids and strokes, along with strong use and interpretation of the music can have a great impact. The Manner of Presentation component allows the pair to command the audience throughout the performance.



2 FREE MIXED DUETS

All rules, routine panels, judgments of routines and percentages are the same as for Duets.

Evaluating Execution, Synchronisation and Difficulty are similar to same- sex duets. However, there are many other considerations under Artistic Impression as follows:

A Mixed Duet needs to represent its own style. It has been accepted in a category of its own so how does the judge evaluate this event artistically?

The Mixed Duet offers the possibility of greater connection between athletes. Captivating and creative actions allow for memorable moments. The partners should establish a connection through strokes, hybrids movements of bodies, legs and arms. There is no required number of connected actions and lifts in the Free Routine but if the music and choreography offer special opportunities, the quality of the Mixed Duet is enhanced.

Showcasing both the man and the woman in definite roles is effective.

Size difference is very likely and this cannot be seen as a problem but rather an opportunity to extend the concept of complementary actions.

Strong emotional impact is an important factor in judging Manner of Presentation of the Mixed Duet. Use of the upper body, faces and eyes create a total picture. The athletes will complement each other while showing strength, flexibility and power.

Finally, the Mixed Duet allows for differences in how we create this innovative program, but an essential element for all should be balance. The programme should demonstrate equality in its choice of actions, should arrange movements that make the routine feel complete and should embrace the concept of a man and woman presenting a vibrant, innovative display of artistry and athleticism.



G. GLOSSARY OF TERMS FOR ROUTINES

Accent	A display of different stress, or emphasis, often in contrast to what has gone before. Stress is differentiated by its greater or lesser force.
Amplitude	Greatness of size, magnitude, fullness, copiousness, breadth or range
Asymmetry	Uneven balance or proportion in time, space or energy. Opposite to symmetry: an arrangement marked by regularity and balanced proportions.
Artistic Impression	An effect, image or feeling retained as a result of demonstration of skill and good taste of the swimmer(s).
Boost	A rapid, headfirst rise, with a maximum amount of the body above the surface of the water.
Choreography	The craft of composing and arranging movement into a comprehensive framework.
Complex	Something made up of or involving an intricate combination of elements.
Creativity	The act of being original or imaginative. Process of formulating a fresh and distinctly personal statement.
Difficulty	The quality of being hard to achieve.
Dynamics	The energy or effort of movement, expressed in varying quality, intensity, texture or gradations in tension.
Eggbeater Kick	With the body in a relatively vertical sitting position, the lower limbs move alternately, as the left foot moves clockwise, and the right foot moves counter clockwise. The technique of the eggbeater kick provides continuous propulsive force for swimmers to maintain the high of the head and upper body above the water.
Energy	Vigour in the exertion of power; strength in action; forcefulness of expression. Varying levels of energy can be displayed through the quality and intensity of the movement and the stressed action or accent of certain notes.



Execution	Refers to the performance level of the skills demonstrated.
Extension	The amount, degree or range to which something can be stretched to its fullest length. Use of muscular strength to enhance the stretch.
Flexibility	the ability to bend or flex, pliable; range of motion
Float	Two or more swimmers attached to make a surface formation.
Fluidity	The ability to move with ease, able to flow, seamless.
Focus	The gathering of forces to increase the projection of intent - e.g. Swimmer's sight line. Adds meaning to movement.
Fuzzy	Lacking in clarity or definition.
Highlight	A portion or detail of a routine of major significance or special interest; a memorable moment.
Hybrid Figure	A figure of mixed origin or composition, and other than those described in the rules.
Intensity	Presence of a greater or lesser degree of energy.
Interpretation of Music	A concept of the music expressed by the performance of the swimmer(s). Use of music.
Jump	Same as Stack . But supported person becomes airborne at peak of lift.
Kinaesthetic Awareness	The ability of the individual to know the spatial relationship of the body parts.
Levels	High/Medium/Low - in relation to water surface. In other words, from high boosts or lifts, to underwater.
Lift	When one or more swimmers give support to lift another swimmer(s) above the surface of the water.



Manner of Presentation	The way in which the swimmer presents his/her routine for the consideration of the public and/or judges. Total command of one's performance, amplitude.
Patterns	Refers to formations made by the spatial relationship between members of a team.
Platform	The coordinated effort of team members to form a stable support on which one or more swimmers is lifted to pose or perform other actions. May be static or moving.
Pool Pattern	The pathway the swimmer(s) take(s) through the water.
Power	The amount of strength or force exerted, might, the rate at which work is done, (strength plus speed).
Projection	Communication of meaning or feeling to the audience.
Propulsion Technique	The process by which the body uses arms and/or legs to move through the water. A driving force.
Rhythm	A structure of movement patterns in time. The pulse or beat.
Risk Factor	Skills which expose the swimmer to a chance of a lesser performance.
Rocket	A <i>Thrust</i> to Vertical Position which does not require the legs to be perpendicular to the surface in the Back Pike Position prior to the <i>Thrust</i> .
Routine	A composition consisting of strokes, figures and parts thereof, choreographed to music.
Spatial Design	Interrelationship of swimmers to each other and to the space through which they are moving.
Stability	Resistant to change, especially sudden change; consistent.
Stack	One person supported at or above the surface.
Strength	The state or quality of being strong, physical power.



Stroke	Refers to swimming strokes. A single complete movement which includes a pull and a recovery of the arms(s) accompanied by an appropriate kick.
Style	A personal or characteristic manner of performing or choreographing.
Sustained height	The ability to maintain a constant level of height above the water.
Sustained Movement	A quality of movement that is smooth and unaccented, with no apparent start or stop, but gives a feeling of a continuity of energy flow.
Synchronisation	To swim or execute movements in unison, one with the other and the accompaniment.
Technical Merit	The level of excellence demonstrated by the swimmer's mastery of highly specialized skills.
Tempo	Pace or speed.
Throw	One or more swimmers being catapulted above the surface of the water by actions of other swimmers.
Transitions	Connecting movements which enable the swimmer(s) to change from one movement to another; stroke to figure; eggbeater to layout; etc.
Trite	Used so often that the novelty has worn off. Stale. Stereotyped. Common place.
Variety	Diversity; assortment. The condition of being varied or diverse.



SECTION IV

REFEREE GUIDELINES



A. THE REFEREE

- To be able to perform effectively as a Referee, an individual must know the rules and how to apply them
 - have common sense, and be able to apply it.
 - be able to analyse the conduct of the competition before, during and after the event.
 - be diplomatic in all interactions with officials, coaches and competitors.
1. The referee will support any testing of new methods and technical rule amendments approved by the TASC that may be tried out in International FINA Competitions provided the following requirements are observed:
 - a) An application must be sent at least three (3) months in advance to the Artistic Swimming Technical Committee and the approval of the latter obtained.
 - b) In the summons of the competition a description must be made as to the kind of innovation to be tried out.
 - c) The Technical Committee will appoint a competent person to oversee the competition and report on the new method.
 - d) On conclusion of the competition the Organizing Member must report on the new method to the Artistic Swimming Technical Committee.
 2. Modifications of a technical nature may be implemented by the Artistic Swimming Technical Committee on a trial basis in International Competitions. Members shall be notified of such modifications through FINA Communication or Circular letter

In the FINA Handbook, **Rule AS 22** defines the duties and responsibilities of the Referee at a competition.

At Olympic Games, World Championships and other FINA events, certain Referee responsibilities are handled by the Commission per **GR 9.5 Commissions**.

To be able to conduct a successful competition, the Referee must have the following at her/his disposal 48 hours before the start of the first competition:

- All rules pertaining to that competition: - FINA plus any Continental, Regional and/or National rule modifications specific to that competition.
- All personnel necessary to organize and conduct the competition. In particular, the Referee requires a suitable number of trained deck officials - Judges; Assistant Referees, Chief Recorder, score keepers, time keepers, clerks of course, music controllers, announcers, runners, video recorder, etc. The competition organizing committee should designate an on-deck liaison to the Referee to deal with logistical organization issues affecting the conduct of the event.



- All the necessary equipment and materials - score cards, music equipment, appropriate seating for the judges, computer scoring whenever possible, judging chits, draw kit, tables, chairs, etc.
- All information regarding entries.

NB: Refer to the FINA Artistic Swimming Operating Manual for detailed lists of personnel, material and equipment requirements; plus task checklists for before, during and after an event.

Prior to the start of the competition, if the athletes have not been registered through the FINA GMS, the Referee must ensure that a procedure is in place to confirm the eligibility of each athlete entered in the event. Depending on the event, that could include some proof of identity, age, affiliation and/or nationality.

AS 22.1 The Referee shall have full control of the event. She/he shall instruct all officials.

To fulfil this task, the Referee must prepare carefully by:

- reviewing and knowing the rules thoroughly
- checking the facilities and all the equipment in advance
- introducing her/himself to the meet personnel and meeting with them to discuss the competition format and organization to ensure smooth operation of the event.
- preparing for and conducting the Team Managers and Judges meetings prior to the start of the competition.
- preparing for and conducting/supervising the draw[s] for order-of-swim.

TASC recommendation: When electronic draws are used, five [5] versions be made with one draw to be drawn manually from the five [5].

For final routine events, see the current FINA Handbook. AS 7, AS 7, AS 13

- overseeing and supervising all officials in any matter relating to the conduct of the actual competition.

During the competition, the Referee must function from a position which enables quick and efficient communication with the assistant referee, judges, announcer, music center manager, chief recorder, scoring and computer personnel, last call room, organizing committee liaison and television staff.

When the event is completed, the Referee ensures that the correct results are available as quickly as possible to enable the organizers to proceed with the award ceremonies in a timely manner. Final results must be signed by the Referee to



certify that they are correct before they will be released to the participants, public and media after each session.

AS 22.2 She/he shall enforce all the rules and decisions of FINA and shall decide all questions relating to the actual conduct of the event and shall be responsible for the final settlement of any matters not otherwise covered by the rules.

To ensure that the competition runs smoothly - particularly when it is being broadcast live on television in a precisely scheduled time period - the Referee must be able to:

- work efficiently and calmly under pressure.
- Analyze the make the correct decision quickly.
- have a common language with the people she/he works

AS 22.3 The Referee shall ensure that all the necessary officials are in their respective positions to conduct the session. He/she may appoint substitutes for any persons who are absent, unable to satisfactorily perform their duty. or have a conflict of interest he/she may appoint additional officials if considered necessary

In addition to satisfy the judges conflict of Interest the referee has the authority to remove a judge from the panel if they discover a judge has not disclosed a conflict of interest. Judges must observe the FINA Code of Ethics section F (Conflict of Interest) and if a judge neglects to declare a situation of a potential conflict of interest, the FINA President or one of the FINA Executive members may refer the matter to the Ethics Panel.

To fulfil this task, the Referee shall schedule a 'check-in' meeting one to one and a half hours prior to the start of each event. Reserve officials should be available to replace any official who is absent, ill, has a conflict of interest or for some reason is unable to function.

The meet organizers should provide an officials' liaison to work with the Referee to ensure that all officials have the necessary equipment [flash cards, clipboards, scoring papers, etc.] and refreshments as needed.

AS 22.4 The Referee is authorized to assign a substitute judge.

One or more reserve judges should be named for each event. They must be present before the start of the event at the judges meeting room with the rest of the designated panel.

AS 22.5 She/he shall determine that the competitors are ready and signal for the start of the accompaniment. She/he shall instruct the scorers to penalize the



competitors in the event of an infraction of the rules. She/he shall approve results before announcements.

Before the results are announced as being official, the Referee or Chief Recorder must ensure that all pertinent information has been included - eg. penalties - and accurately processed, with all the scores accurately recorded, calculated and in agreement with the back-up system. When everything has been checked, the Referee signs the result sheets to certify that they are correct. If a penalty for any reason or a deduction (to required elements in technical routines) is to be applied, the Referee must assure the coach or delegate of the affected participant is informed in time to permit them to present a protest if they wish to do so.

AS 22.6 The Referee may intervene in the event at any stage to ensure that the FINA regulations are observed, and shall adjudicate all protests related to the event in progress.

- If swimwear does not conform to **GR 5** and/or **AS13.8-AS13.11**, the Referee has the authority to not allow swimmers to compete until they change into something appropriate.
- When a technical problem occurs during a routine performance, the Referee may allow a re-swim.

Guidelines for timing of a re-swim:

- if less than half of the routine has been performed, schedule re-swim after the next 2 routines. [approximately 15 minutes' recovery time]
- if more than half of the routine has been performed, schedule re-swim after the next 3 routines. [approximately 20 minutes' recovery time]
- if the original start number was just prior to a break, the routine could re-swim as the first competitor after the break.
- if a problem occurs during the final routine of an event, the Referee should determine a suitable recovery time - ie. 10-15 minutes, or sooner if the athlete(s) is/are ready - and ask the officials to remain in their places until the re-swim has occurred.
- When a technical problem such as power failure; no underwater music; weather conditions, etc., necessitates a re-swim, the Referee should inform the Coach personally, and the officials and audience through the announcer.
- A Solo, Duet, Mixed Duet, Team Tech, Team Free, Free Combo or Highlight Routine can be asked by the referee to swim earlier than scheduled. The athletes will have 2 minutes to prepare themselves and then must walk on and be ready to compete.

Referee must be knowledgeable in the protocol and the procedures for handling of a



protest according to GR 9.2 Protests

AS 22.7 The Referee shall disqualify any swimmer or coach for unacceptable behavior and any violation of the rules that she/he personally observes or which is reported to her/him by other officials.



SECTION V

MEDICAL ISSUES IN ARTISTIC SWIMMING



A. ILLNESSES IN ARTISTIC SWIMMING

1. ASTHMA

The prevalence of asthma in Artistic Swimming at the Olympic Games in Beijing in 2008 was the second highest of all sports at 21.2%. The overall incidence of asthma for all sports was 7.2%.

Postulation on the cause of this high prevalence of asthma in Artistic Swimming as an endurance discipline suggests that this may be the result of chronic exposure of the lungs to environmental allergens while breathing rapidly and deeply during endurance training. The exposure of the lungs to irritant chloramines, by-products of chlorine, is considered to be a major factor. Partial reversibility of these findings appears to occur upon retirement from elite sport. More research is required to determine a strategy to minimize or reduce the adverse effects of training on airways.

Treatment of asthma in the elite artistic swimmer is restricted by the conditions of the World Anti-Doping Association as many of the inhaled treatments (beta2agonists) are prohibited. Attention to these requirements is essential to avoid an anti-doping rule violation. Medical attention should be sought in the artistic swimmer who complains of prolonged intermittent cough, wheezing, difficulty breathing or chest tightness.

2. RELATIVE ENERGY DEFICIENCY in SPORT (RED-S)

Relative Energy Deficiency in Sport (RED-S) is a clinical syndrome resulting from **relative energy deficiency** that affects many aspects of physiological + psychological function beyond menstrual cycle and bone health. The IOC has defined RED-s as a syndrome that

“refers to impaired physiological functioning caused by relative energy deficiency, and includes but is not limited to metabolic rate, menstrual function, bone health, immunity, protein synthesis, and cardiovascular health”

RED-s is caused by **Energy deficiency** relative to the balance between the *energy intake* and the *energy expenditure* of homeostasis (beating heart, body functions, + the physical activity of daily living (walking and moving) + sport activity

. Energy availability is defined as energy intake minus energy expenditure. An athlete runs into difficulty when their energy output exceeds their energy intake. This can occur as a result of an eating disorder or by disordered eating. In some cases, an energy deficit can occur in the absence of these scenarios simply by inadequate intake of nutrition to meet the energy output or prolonged exercise. One physiological result of the energy deficit is menstrual dysfunction ranging



in a spectrum from an abnormal menstrual cycle to a complete lack of menses (amenorrhea). Another consequence to the energy deficit is altered bone health. This can range from optimal bone health to progressive thinning of the bone known as osteoporosis. In athletes, the first presentation of unhealthy bone density is often a stress fracture. This may go unrecognized in Artistic Swimming during an athlete's competitive years due to the relatively low impact of training, however healthy bone mass density is necessary to prevent problems later life. Other body systems can also be affected as seen in the diagram below:

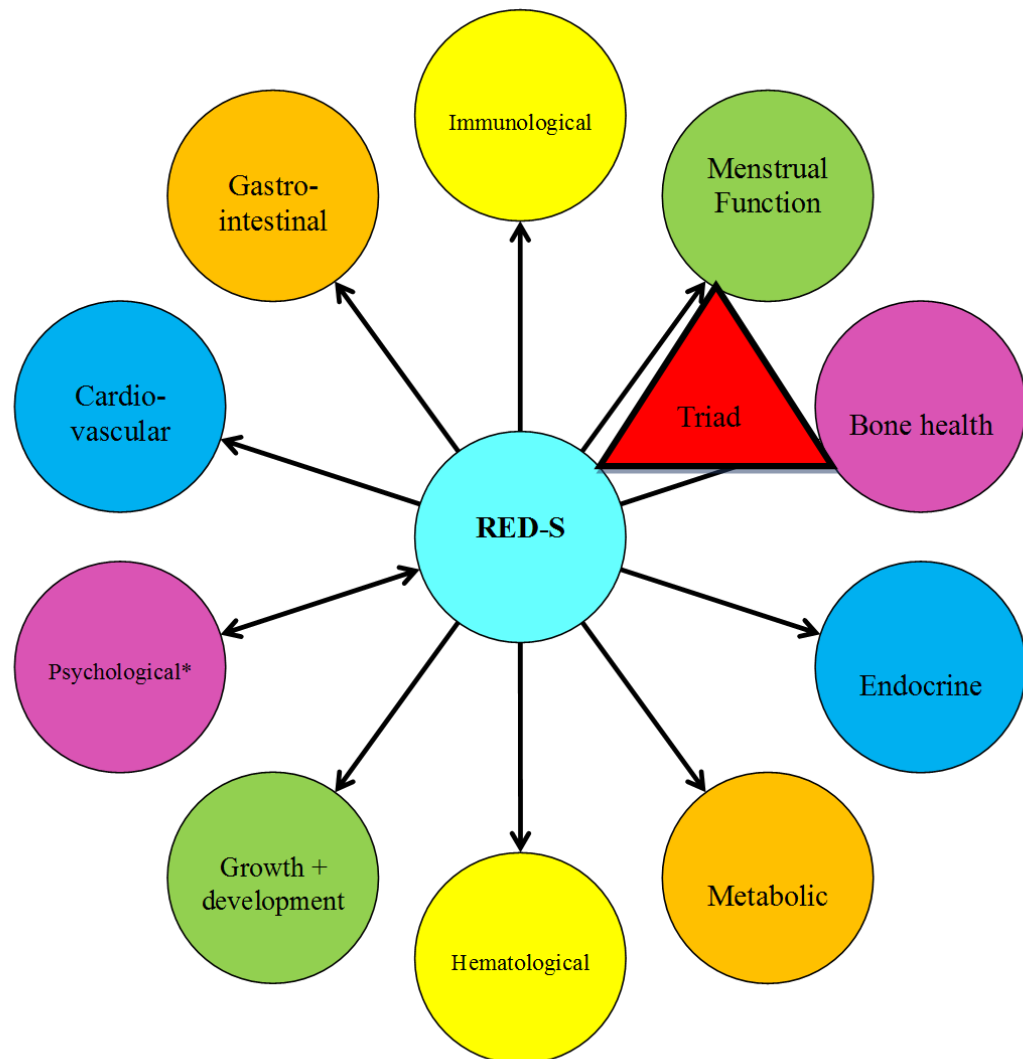

RED-S can also negatively affect athlete sport performance.

The exact prevalence of the Triad in Artistic Swimming is unknown however it is often seen in clinical practice.



An artistic swimmer who does not have one or more of the body systems affected in the diagram above should seek medical attention to rule out the presence of the RED-S.

3. EATING DISORDERS / DISORDERED EATING

The sports medicine scientific literature clearly acknowledges that athletes in esthetic sports such as Artistic Swimming are at higher risk for developing an eating disorder or disordered eating.

Due to the judged nature of Artistic Swimming, there is a pressure for these athletes to be lean and thin. In some cases, this may lead to a clinical eating disorder or disordered eating. An eating disorder is a psychiatric diagnosis characterized by a disturbance in eating behaviors. There are four types of eating disorders: anorexia nervosa, bulimia nervosa, binge eating disorder, and other specified and unspecified feeding or ED (OSFED). Anorexia nervosa is characterized by marked restriction of eating with a 15% weight loss from expected norm. Despite this, the athlete feels overweight and has a fear of gaining weight. Bulimia nervosa is characterized by repetitive cycles of bingeing –eating followed by purging. They are usually of normal weight.

Disordered eating occurs when there are abnormal eating behaviors which are not severe enough or have occurred long enough to meet the diagnostic criteria for an eating disorder. The prevalence of eating disorders in esthetic sports that emphasize leanness in the literature ranges between 18 - 45% in comparison to 5% in the general population. A desire to be leaner to enhance performance seems to predict later development of disordered eating. Finally, disordered eating seems to be influenced by perfectionism, competitiveness, pain tolerance and the perceived performance advantage of weight loss.

The consequences of eating disorders are serious affecting both the physical and psychological health of the athlete. Psychological sequelae include depression, anxiety and low self-esteem. Physical sequelae of eating disorders affect all body systems. There is a six-fold mortality rate with a high suicide rate. Prognosis for long term recovery from eating disorders is guarded. This health issue is a serious problem for athletes in esthetic sports – and in particular for artistic sports.

Management of Eating Disorders

In a non-threatening environment, the athlete is more likely to accept support and minimize the risk of progressive illness. Another initiative which may assist in the early stages of managing the anorexic athlete includes psychotherapy with a trained sport psychiatrist/psychologist. Nutritional advice and the establishment of firm weight goals in consultation with the team physician are also recommended. Prevention through sensitive and private body composition measurements, as well as educational initiatives are recommended.



4. HYPOXIA

Prolonged breath holding carries with it the risk of Hypoxia [reduced blood oxygen]. When associated with physical activity in an underwater setting, the potential for loss of consciousness [‘black out’] is of significant concern. Available medical evidence strongly suggests that the combination of prolonged breath holding - more than 45 seconds - and vigorous physical activity can have serious medical consequences. ‘Black out’ under water is clearly a serious and potentially lethal situation.

Hyperventilation [over breathing] prior to a competition is also known to increase the risk of a black out and should be actively discouraged. The practice of hyperventilation lowers the levels of carbon dioxide in the blood stream and abolishes an important trigger for normal breathing.

Hypoxia has been demonstrated in Artistic Swimming resulting in confusion in the past. At this time, the emphasis in Artistic Swimming routines was on prolonged breath-holding. The style in Artistic Swimming has changed since then to a more acrobatic and artistic style with emphasis on execution and less emphasis on breath-holding. Although hypoxia is now rare, coaches should be aware of this phenomenon and prevent prolonged breath holding practices.



B. INJURIES IN ARTISTIC SWIMMING

1. SHOULDER

In Artistic Swimming, the commonest cause of injury to the musculoskeletal system is overuse. The artistic swimmer trains for cardiovascular fitness by swimming freestyle. In addition to this training, she also does repetitive synchro-specific skills such as arm actions in routines, support scull with lifts and boosts and dry land drill –an on-land rehearsal of the routine. These activities occur repetitively for several hours on a daily basis. All of these repetitive actions over time may result in micro-trauma to the rotator cuff muscles of the shoulder. Another mechanism may be impingement of inflamed soft tissue structures of the shoulder such as the subacromial bursa.

Flexibility and balanced muscle strength are essential requisites for all successful artistic swimmers.

The artistic swimmer with a shoulder injury will complain of pain of lifting the arm away from the body or of shoulder movement which progresses to the point where the swimmer is unable to continue training.

The Management of Shoulder Pain in Artistic Swimmers

The successful management of shoulder pain in any swimmer demands the cooperation of athletes, coach, physician and other allied healthcare expertise. Management begins with an accurate clinical diagnosis, which is the prime responsibility of the sports physician. To distinguish between the various causes of shoulder pain, a full clinical examination followed by specialized ultrasound, MRI or CT scans may be necessary.

Early conservative management includes rest from all provocative activities. A swimmer could still attend training and do kicking drills or dry land workouts. The use of ice massage and other physiotherapy modalities should be included. The correction of technical problems may require video analysis and biomechanical expertise, and there will be obvious input from the coach. Communication between physician, athlete and coach is essential.

The Artistic swimmer is able to maintain aerobic fitness during rehabilitation by incorporating cross training activities into the program. For example, while resting an injured shoulder, cycling, jogging and kicking drills are appropriate alternatives.

Return to sport demands the recovery of full pain free movement. If poor technique has been ignored, then it is only a matter of time before symptoms return and the vicious cycle of pain and limited movement returns.



2. LUMBAR SPINE

Resulting from the fast mechanical movements seen in Artistic Swimming team and duet events, the lumbar spine of the Artistic swimmer is particularly vulnerable to injury. Injury to the lumbar spine is thought to be caused from the repetitive and rapid arching. A unique move in Artistic Swimming that adds further stress on the lumbar spine is the 'rocket-boost' and the 'knight' position. Training errors can be blamed for the development of lumbar dysfunction and should be taken into consideration when evaluating the athlete for the cause of the injury and when developing the treatment plan. These errors include excessive repetitions, explosive speeds, arching with a rotational component, excessive over-arching, inadequate neuromuscular training, poor core stability & posture, inadequate flexibility and premature progression to higher risk skills.

There are many injuries that occur to the lumbar spine. These range from muscle strains to more serious injuries including stress fractures of the spine (spondylolysis) or neurological compromise requiring urgent medical intervention. The athlete who complains of lumbar pain should seek medical attention. A thorough physical examination and appropriate imaging studies as indicated are necessary to ensure the accurate diagnosis and subsequent treatment plan.

3. KNEE

Like the breast-stroker and the water polo player, the Artistic swimmer is vulnerable to chronic overuse injury of the knee. This can be attributed to the egg beater kick. Progressively difficult egg beater drills are used as foundation training for the development of strength and skill.

The Artistic swimmer may present with either medial or anterior joint pain. The medial joint pain can be explained by the medial joint stress caused by the positioning of the knee during the egg beater kick. Anterior joint pain is attributed to abnormal tracking of the knee cap in the notch of the femur. The athlete will complain of stiffness after rest and anterior knee pain while kneeling and using the stairs. It may be aggravated by the eggbeater kick at later stages.

Knee pain in the Artistic swimmer most often can be managed with non-surgical interventions. Alteration to the duration and intensity of the egg beater kick during training is necessary. Cross training on the bicycle for fitness is preferred to jogging during the rehabilitative process which may aggravate knee injuries.



4. CONCUSSION

Emphasis in recent years in Artistic Swimming has been on the development of high-risk acrobatic moves especially in the team routine.

The brain is a complex organ that does not respond well to trauma. It often does not heal as predictably as bony or muscular injuries. This unpredictability may lead to difficulty in detection, treatment and recovery from concussion.

Concussion is defined as:

- *A disruption of brain function caused by an external force AND*
- *Manifests as an alteration of attention or mental state AND*
- *Is indicated clinically by new onset or worsening of a range of evolving signs and symptoms that are influenced by both intrinsic and extrinsic factors*
- **Exclusion:** *Manifestations of concussion must not be due to: drugs, alcohol, medications, caused by other injuries or treatment for other injuries or caused by other factors such as psychological trauma, language barrier, or co-existing medical conditions*

Several common features that incorporate clinical, pathological and biomechanical injury constructs that may be utilized in defining the nature of a concussive head injury include:

1. Concussion may be caused either by a direct blow to the head, face, neck or elsewhere on the body with an “impulsive” force transmitted to the head.
2. Concussion typically results in the rapid onset of short-lived impairment of neurologic function that resolves spontaneously.
3. Concussion results in a graded set of clinical syndromes that may or may not involve loss of consciousness. Resolution of the clinical and cognitive symptoms typically follows a sequential course. However it is important to note that in a small percentage of cases post-concussive symptoms may be prolonged.
4. Concussion does not result in an abnormality on standard structural neuroimaging studies.



The diagnosis of concussion should be considered by coaches in the Artistic swimmer who has had a blow to the head if she portrays any of the following scenarios:

- (a) Symptoms - somatic (e.g. headache), cognitive (e.g. feeling like in a fog) and/or emotional symptoms
- (b) Physical signs (e.g. loss of consciousness, amnesia)
- (c) Behavioral changes (e.g. swimming the wrong way)
- (d) Cognitive impairment (e.g. slowed reaction times)
- (e) Sleep disturbance (e.g. drowsiness)

The artistic swimmer who is suspected to have a concussion should seek immediate medical attention. Return to training should occur under medical supervision and only occur once the athlete is completely symptom free and has undergone a graduated program of increasing cognitive challenges (return to learn, or return to work) followed by a graduated program of increasing physical activity (return to play) with no recurrence of symptoms.



SECTION VI

GUIDELINES FOR APPROPRIATE CONDUCT AT COMPETITIONS



A. GENERAL CONDUCT

Coaches and other team personnel should:

- Exemplify conduct they wish their athletes to adopt in dress and behaviour.
- Accept responsibility for their athletes' conduct.
- Demonstrate mutual respect among themselves and towards personnel of all entries.
- Cooperate fully with meet organisers and officials during practices and events.

B. CONDUCT DURING PRACTICES

Coaches should follow guidelines for practice procedures as provided by meet management, and ensure that their athletes clear the pool as soon as their practice time is over.

1. With Music

- Coaches have the right to deny other teams access to the pool during their allotted music spacing time.
- If a coach wishes to make use of the pool during another team's designated time, she/he must ask permission of that team's coach, and abide by the decision.
- When a team uses the pool during another team's music time, it should only be for figure and/or routine elements which do not require audible marking of time – i.e. 'banging' - or infringe on the designated team's use of the pool space.

2. Without Music

- During open practices which are scheduled for a specific event, coaches should have only the swimmers for that specific event in the pool. For example, only Solos swim during Solo time.
- 'Banging' is not allowed at any time.
- Request permission of meet management to use unscheduled empty pool space between events.



3. For Figures Competitions

- When practice time is divided due to a large entry, decisions of management are to be respected. Athletes practice only in that portion of the time and pool to which they are assigned.

C. CONDUCT DURING THE COMPETITION

- All team personnel should keep clear of music centres, scoring tables and judge panels. The referee will ensure coaches and teams remain in designated areas throughout the sessions to ensure smooth delivery of the event.
- Coaches and all team personnel must be in special team designated areas.
- Applause for a performance should be in an appropriate manner. Screams and screeches as expressions of enthusiasm and support for friends or team-mates can be annoying to spectators, distracting to judges and may have a negative impact on the atmosphere the performance is attempting to establish. This is at the discretion of the referee



FINA
Chemin de Bellevue 24a/24b
CH – 1005 Lausanne
Switzerland

© Fédération Internationale de Natation

